

STROBE APPROACH LIGHTING TECHNOLOGY

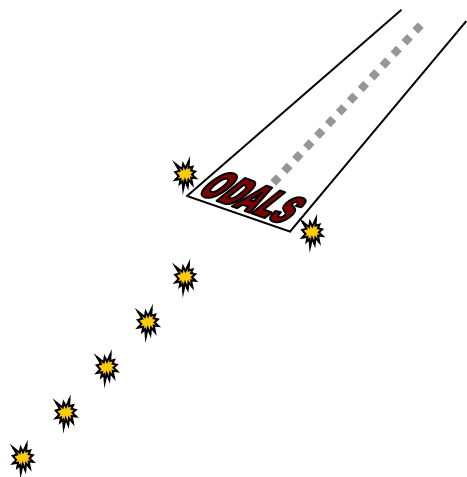
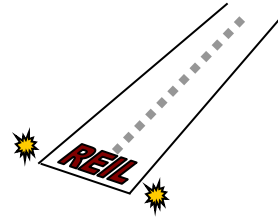

OMNI-DIRECTIONAL
CURRENT-DRIVEN
APPROACH LIGHTING SYSTEM

L849 & L859-I Style B,F USER'S MANUAL

STROBE APPROACH LIGHTING TECHNOLOGY
108 Fairgrounds Drive Manlius NY 13104
315.682.6460

SCOPE

This manual contains Installation, Operation, and Maintenance information for Current-Driven Omnidirectional Runway Approach Lights manufactured by Strobe Approach Lighting Technology (SAL Technology®), Manlius, NY, USA.

CARTON LABELING

Each carton contains one complete light consisting of a power supply and a flash head. If your system consists of two lights (i.e., an L-849, Style F system), one carton will be labeled Master and the other labeled Slave.

If your system consists of seven lights (ODALS, L-859, Style F) the carton containing the master unit will be labeled as Master, Light A. Another carton will be labeled as Light B. The remaining cartons will be labeled as Light #1, Light #2, and so on. The placement of these lights is shown in Figure 6 of this manual.

Some systems may have accessory items that require separate packaging. Those packages are also appropriately identified.

In addition to a power supply and flash head, each carton contains two frangible fittings with short EMT couplings for power supply installation. An Owner's Manual is included in the carton containing the master unit.

UNPACKING

Inspect each shipping carton for external damage immediately upon receipt. There could be damage to the contents if the carton is damaged. Promptly file a claim with the freight carrier if you have received damaged equipment.

TOOLS REQUIRED

#2 Phillips screwdriver; 10-inch shank.

1/4-inch, flat blade screwdriver; 10-inch shank.

1/8-inch, flat blade screwdriver; short shank (for circuit board potentiometer adjustments).

Water pump pliers opening to 3-inches (for 2-inch EMT compression fittings).

Wire strippers.

Wire cutters (for small gage wire).

Spirit or digital level (for leveling a co-mounted power supply).

Volt-Ohm meter; 1000-volt range.

ABBREVIATIONS USED IN THIS MANUAL

PSOC → Power Supply Omni-directional Current

FHOD → Flash Head Omni-Directional

ODALS Omni-Directional Approach Lighting System

REIL → Runway End Identifier Lights

SLC → Series Lighting Circuit

NPT → National Pipe Tapered (thread)

EMT → Electrical Metallic Tubing

DISCLAIMER

The information in this manual is believed to be accurate and up to date, however, Strobe Approach Lighting Technology assumes no liability for damages or injuries that may result from errors or omissions, or from the use of information presented herein. Strobe Approach Lighting Technology reserves the right to modify this manual at its discretion without notification to any person or organization.

APPLICABLE SPECIFICATIONS

This equipment meets or exceeds the requirements in the FAA Advisory Circular, AC 150/5345-51A, and is listed as FAA approved equipment in AC 150/5345-53, Addendum B.

WARRANTY

Strobe Approach Lighting Technology warrants that this equipment has been manufactured and will perform in accordance with applicable specifications and that may defect in design, materials, (excluding lamps,) or workmanship which may occur during proper and normal use during a period of 1 year from date of installation or at least 2 years from date of shipment will be corrected by repair or replacement by the manufacturer FOB factory.

USE OF GENERIC PARTS

Using parts not manufactured or supplied by Strobe Approach Technology, or unauthorized modification of any part of this equipment, voids the warranty and could render the equipment noncompliant with applicable FAA specifications.

CONTACT INFORMATION

Strobe Approach Lighting Technology may be contacted by the following methods:
Tele: 1.315.682.6460
Email: sales@saltechnology.com

WARNING

Dangerous Voltages

This equipment generates voltages that are dangerous to personnel. Use appropriate caution while operating or servicing this equipment.

Capacitors can retain a substantial charge even after power has been removed. Allow at least one minute after turning off the power for the capacitors to be drained of charge—then check the safety lamps inside provided for this purpose.

Do Not Depend on Interlocks

Never depend on an interlock switch alone to render the equipment safe. Always look for the condition of the **High Voltage Indicating Lights** and check circuits with a voltmeter.

Do not disable the safety interlock switch.

TABLE OF CONTENTS

	Page
Front Matter -----	i-iv
Carton Labeling -----	i
Unpacking -----	i
Tools Required -----	i
Abbreviations Used In This Manual -----	i
Applicable Specifications -----	ii
Warranty -----	ii
Use of Generic Parts -----	ii
Contact Information -----	ii
Table of Contents -----	iii
List of Figures -----	iv
List of Tables -----	iv
Abbreviations -----	iv
General Description -----	1
Access -----	2
Re-installing The Lens -----	2
Equipment Specifications -----	3
Installation -----	4-6
Mounting the Power Supply -----	4
Primary Power Hookup -----	5
Control Line Hookup -----	6
Functional Description -----	7
Applications -----	7
Programming -----	8
Setup Procedures -----	9-12
Three Levels of Intensity From a 3-Step CCR -----	10
Three Levels of Intensity From a 5-Step CCR -----	11

Single Intensity Setup	12
Theory of Operation	13
Maintenance	14
Troubleshooting	15-20
Status Lights	16
Normal Indications	17
Problems At Installation	18
Evolving Problems	19, 20
Replacing Flash Head Components	21-22
Flash Tube	21
Trigger Transformer	22
Replaceable Parts	23

LIST OF FIGURES

PAGE

1a: Power Supply -----	1
1b: Flash Head -----	1
1c: Co-Mounted Unit-----	1
1d: Lens Details -----	2
1e: Lens Clamp Detail -----	2
2: Mounting The Power Supply-----	4
3: Electrical Connections -----	5
4: Control Line Connections -----	6
5a: PCB-1 Photo -----	7
5b: PCB-2 Programming Switches -----	7
6: Circuit Board Programming -----	8
7: Current Sensing Adjustments -----	9
8: Flash Head Sealing -----	14
9: Power Supply Component Identification -----	15
10: Flash Head Internal Components -----	15
11: PCB-1: Status Lights -----	16
12: PCB-2: Status and Safety Lights -----	16
13a Flash Tube -----	21
13b Flash Tube Bracket -----	21
14a HV Coil Removal -----	22
14b T101 Partial Assembly -----	22
15: Component Location Diagrams -----	23

LIST OF TABLES

Table 1: Three-Step CCR -----	9
Table 2: Five-Step CCR -----	9
Table 3: Relay Mode Conditions -----	20
Table 4: Replaceable Parts -----	23

GENERAL DESCRIPTION

This equipment is classified as an omni-directional discharge flashing light (strobe). Each light consists of a power supply and a flash head. A power supply (Figure 1a) may be either a master unit or a slave. The catalog designation for a Master power supply is PSOC-107; a Slave power supply is PSOC-108. The Flash Head (Figure 1b) in either case is FHOD-110. The flash head may be attached directly (co-mounted) to a power supply enclosure (Figure 1c) or installed separately and connected by up to 100 feet of suitable cable. The cable can be furnished by SAL Technology®. The power supply operates from a Series Lighting Circuit driven by an L-828 Constant Current Regulator, Class 1, Style 1 or 2.

This equipment does not require an intermediate Series Circuit Adapter.

It is specifically designed and tested to meet the requirements for L-849I, Style F (REIL), and L-859I, Style F (ODALS) as defined in the FAA's "Specification for Discharge-Type Flashing Light Equipment", AC 150/5345-51A.

L-849I and L-859I are designations used by the FAA for current-driven flashing lights for runway approach lighting applications.

L-849I and L-859I lights from SAL Technology® are certified by third party testing under the FAA's Airport Lighting Equipment Certification Program (ALECP).



Figure 1a, Power Supply



Figure 1b, Flash Head



Figure 1c, Co-Mounted Unit

ACCESS

The power supply cover is secured by quarter-turn latches on the two front corners of the enclosure. These latches may be padlocked for security. A co-mounted unit also has two self-releasing latches across the hinge. The hinged cover when fully opened is supported by a lanyard.

Access to flash head components requires removing the lens which is held to the base plate by six clamps secured by screws. Loosen but do not remove the screws, and then lift the lens straight up from the base and set it aside. The flash head does not have to be accessed for installation, even if it is mounted separately.

CAUTION

Follow Instructions for Proper Re-installation of the Lens.

RE-INSTALLING THE FLASH HEAD LENS

Three tabs or “feet” extend beyond the lower body of the lens. **Although the lens rests on these tabs they are not used to secure the lens to the baseplate.** These tabs must, however, be properly positioned in order to clear other objects attached to the base plate (See Figure 1d). A positioning guide is provided in the form of an outline of one of the tabs. Locate one of the tabs within the outline provided, and secure the lens as described below.

After the lens has been properly positioned on the base plate each clamp can be loosely engaged into the **first lens groove** as shown in Figure 1e. Starting with any clamp, lightly tighten it, and then skip to the one opposite. Proceed around the lens in this manner until all of the six clamps are lightly tightened. Be sure that the lens clamps are fitted into the first groove above the base plate. Now repeat the tightening pattern, and this time firmly tighten each one.

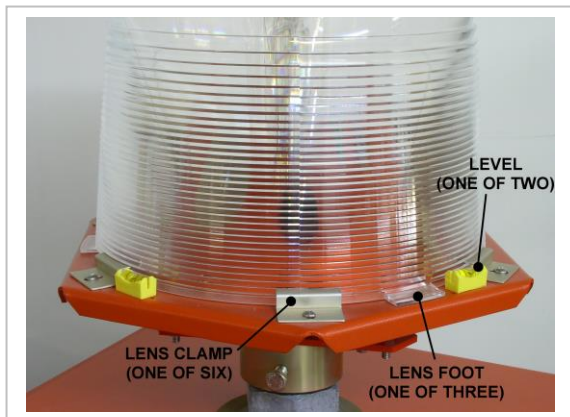

**Figure 1d
Lens Details**

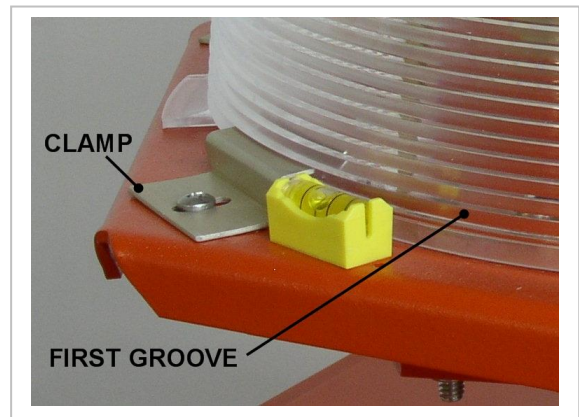

**Figure 1e
Lens Clamp Detail**

EQUIPMENT SPECIFICATIONS

PHYSICAL: Dimensions are in inches (mm); Weight in lbs (kg).

PSOC-107 & 108, Power Supply, (Figure 1a).

Dimensions ----- 8H x 16W x 14D (203 x 406 x 356)

Weight: ----- 51 (23.2)

FHOD-110, Flash Head, (Figure 1b).

Dimensions: ----- 15H x 13.5 Dia. (381 x 343)

Weight: ----- 8.4 (3.8)

Power Supply and Flash Head (Co-mounted, Figure 1c).

Dimensions: -----23H x 16W x 14D (584 x 406 x 356)

Weight: -----59.4 (27)

OPERATIONAL:

Current (rms Amps): -----2.8 to 6.6

5.2 Amps Min. required for High intensity

Power: (Watts) -----150 Ave; 290 Peak

Flash Rate (Flashes Per Minute): -----60

Intensity (Effective Candelas, total beam spread): --High: 2500 to 7500

Med: 750 to 2250

Low: 150 to 450

Beam Spread: -----360° Horizontal, 10° Vertical.

AVAILABLE OPTIONS: (Must be factory installed)

Flash Monitoring

Elapsed Time Meter

INSTALLATION

Installation consists of mounting the power supply onto previously prepared supports and making electrical connections. Some installation details could depend on site drawings and specifications originated by others. Basic requirements are given below.

If you are installing a system with sequentially flashing lights you should place each light in its assigned position. Lights identified as A & B are meant to be installed at the runway threshold. Light #1 is intended to be nearest to the runway threshold. Light #2 is intended to be next, and so on. A light that has not been placed in its intended position can be re-programmed using the information in Figure 10. A light that has not been placed in its intended position can be re-programmed using the information in Figure 6.

MOUNTING THE POWER SUPPLY

The power supply requires two, 2-inch NPT base supports at ground level such as NPT flanges anchored in concrete at a spacing of 8.00 inches center to center, or a burial can cover with threaded entrance holes at the required spacing.

The power supply itself is provided with two attached, 2-inch, EMT compression fittings. Frangible fittings shipped with the equipment have male threads at one end and 2-inch EMT compression fittings at the other. Each one is furnished with a short (2-½ inch) length of EMT by which they may be coupled to the compression fittings on the bottom of the power supply enclosure.

The frangible fittings must first be screwed into the ground supports and securely tightened. The EMT couplings must be adjusted to extend out of the frangible fittings by ¾ to 1-inch and the compression nuts securely tightened. Set the power supply down over the two EMT couplings and securely tighten the compression nuts.

A power supply with a co-mounted flash head meets the maximum height restriction set by the FAA when installed as described above and as shown in Figure 2. The 2-½ inch long EMT sections may be replaced by slightly longer sections if local conditions require raising the elevation of the light source by a few inches. This is not recommended for a substantial increase in light center elevation; mounting the flash head on a separate support while leaving the power supply close to the ground is recommended instead.

Please note that separate flash head mounting is not intended as a field option. The method of flash head mounting should be specified when the equipment is ordered.

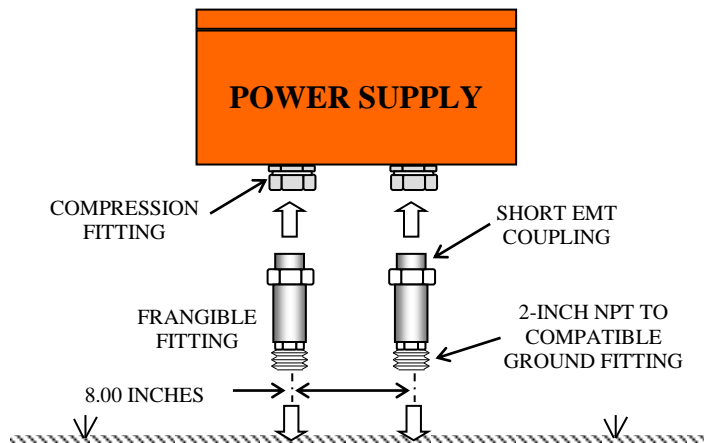

Figure 2, Typical Mounting Details

INSTALLATION (Cont.)

PRIMARY POWER HOOKUP See Figure 3.

Each light requires an L-830-10 (300 watt) Isolation Transformer connecting the power supply to the Series Lighting Circuit. This transformer is normally supplied by others, although it can be purchased from SAL Technology® and shipped with the equipment as an optional item.

A 72-inch long L-823 Cord Set is provided as part of each power supply and is pre-attached at the factory. The cord set has a molded plug compatible with the molded socket on the secondary winding of an L-830 transformer. The cord set is arranged to conveniently exit through the 2-inch EMT support on the LEFT side of the power supply (as you face the opened cover). Connecting primary power therefore consists only of feeding the two-wire cord set through the EMT support and plugging it into the mating socket on the L-830-10 transformer.

Each power supply should be grounded locally for protection against lightning damage. An external grounding lug on the bottom of the power supply enclosure is provided for this purpose.

A grounding rod should be installed at each power supply for the best protection.

GROUNDING THESE POWER SUPPLIES TO A COUNTERPOISE COULD INCREASE THE RISK OF DAMAGE DUE TO LIGHTNING

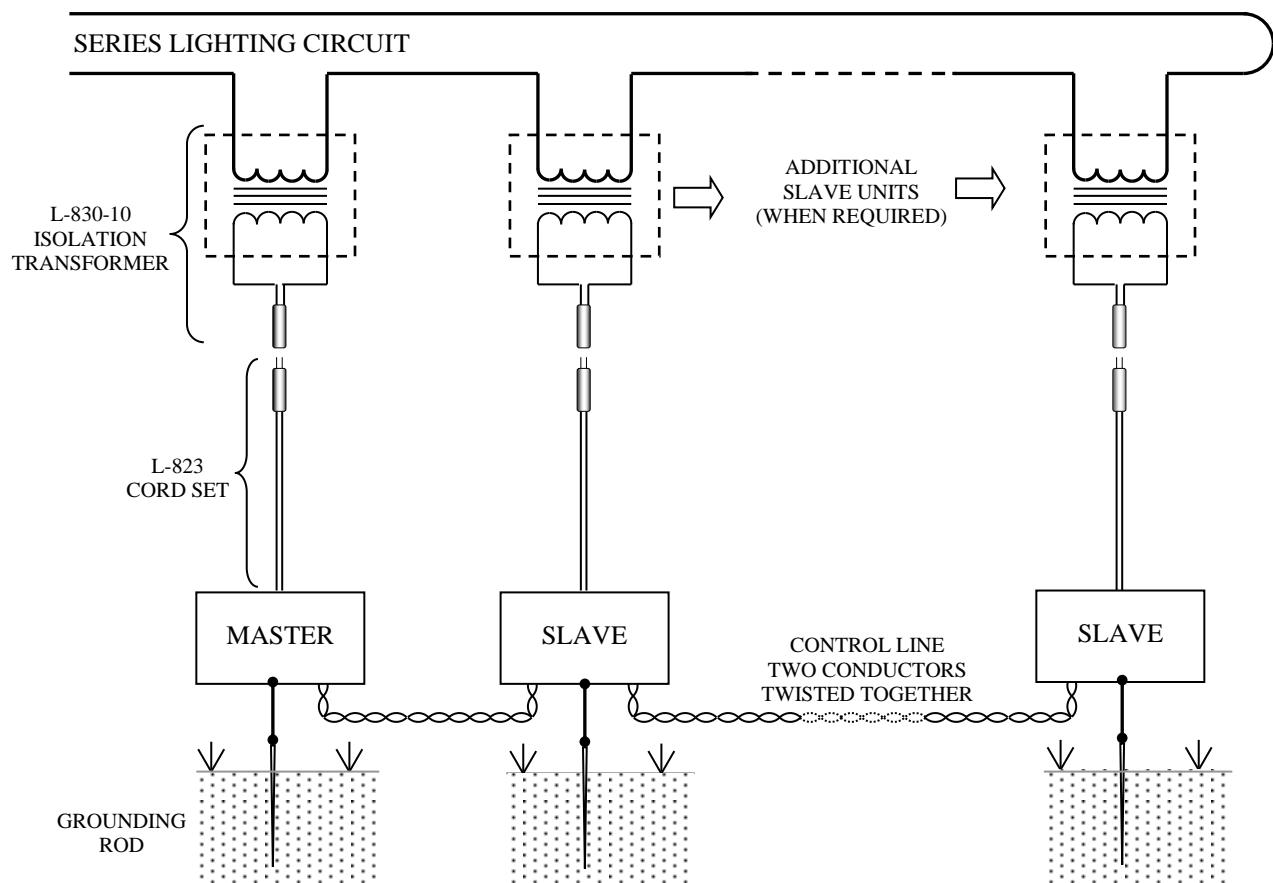

Figure 3, Typical Electrical Connections

INSTALLATION (Cont.)

CONTROL LINE (See Figures 3 & 4)

The power supplies must be interconnected by a two-conductor control line. These conductors must be twisted together to minimize effects from electrical fields in close proximity, and especially from power conductors. The ideal control line consists of two stranded AWG 12 conductors twisted together with 3 to 4 twists per foot. A shielded cable is neither required nor recommended. AWG 12 wire is cited only for its mechanical strength; it is not an electrical requirement because the control signal current is very low.

Control line connections are made at TB1 in each power supply, on Terminals 3 and 4. Terminal 3 carries the driving signal, and Terminal 4 the return. Terminal 4 is also tied internally to the equipment chassis.

Be sure the wires are inserted into the terminal block cavities between the two clamping plates. The clamping screws must be firmly tightened to assure long-term reliability. Always tug on the wires after the terminal block screws have been tightened to test them for secure holding. This is especially important when more than one wire is inserted under a clamp.

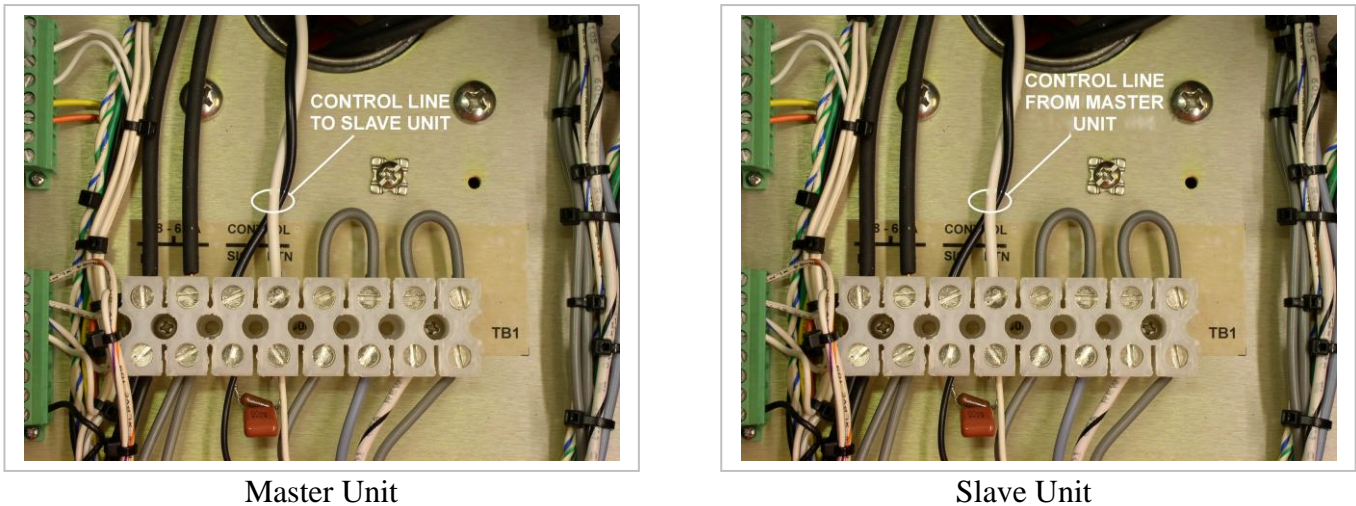

Figure 4, Control Line Connections

Figure 4 depicts control line connections in a master unit and a slave. When there are multiple slave units as in an ODALS the control line must be “daisy chained” from one slave unit to the next as inferred in Figure 3. Since the daisy chain connections are made at Terminals 3 and 4 there will be two conductors at those positions in all but the first unit (the master) and the last slave unit in the chain.

FUNCTIONAL DESCRIPTION

The main circuit board, PCB-1, is identical in each power supply whether it is a master unit or a slave. They communicate with one another over the interconnecting control line. Master units have an additional circuit board, PCB-101, that is part of a CSM-112 Current Sensing Module. The current sensing module monitors the level of current in the Series Lighting Circuit (SLC) and provides adjustments for setting flash intensity switching levels. The equipment was set up at the factory to comply with sales order details concerning flash intensities, but it will likely be necessary to “fine tune” the adjustments in the field due to the many variables that can affect these adjustments, such as the type of CCR (3-step or 5-step) driving the SLC, and the presence of other loads. This is especially true of CCRs that do not produce a sinusoidal current waveform. Some applications require only one level of intensity. Set up procedures are on pages 9 through 12 of this manual. Slave units do not require set up adjustments.

APPLICATIONS

An ODALS by definition consists of seven omni-directional strobes flashing in a prescribed sequence. There are five lights situated on a line defining the approach to a runway’s centerline and two lights (REILs) at the runway threshold. The lights flash sequentially towards the runway. The threshold lights flash last and they must flash simultaneously. Switch SW1 on PCB-1 controls when the light will flash; SW2 controls the rate at which flashes repeat. The rate for an ODALS is 60 flashes per minute. These switches are initially set at the factory to comply with the application as ordered, although changes can easily be made in the field.

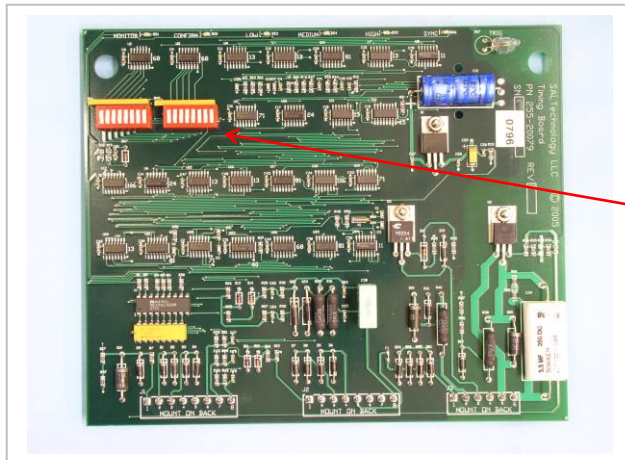

Figure 5a
PCB-1

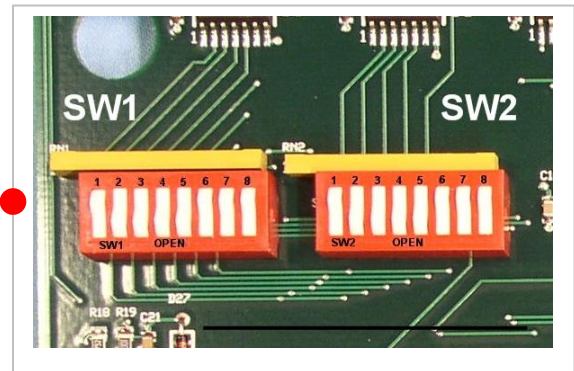

Figure 5b
Switch Detail

Figure 6 shows SW1 and SW2 programming requirements for an ODALS (FAA Type L-859, Style F). Lights #1 through #5 must flash sequentially with #5 flashing first. The threshold lights, identified as A & B, must flash simultaneously after light #1 has flashed. The sequence repeats at one-second intervals. Since lights A & B must flash simultaneously they must be programmed identically.

A Type L-849I, Style F system consists of lights A & B only.

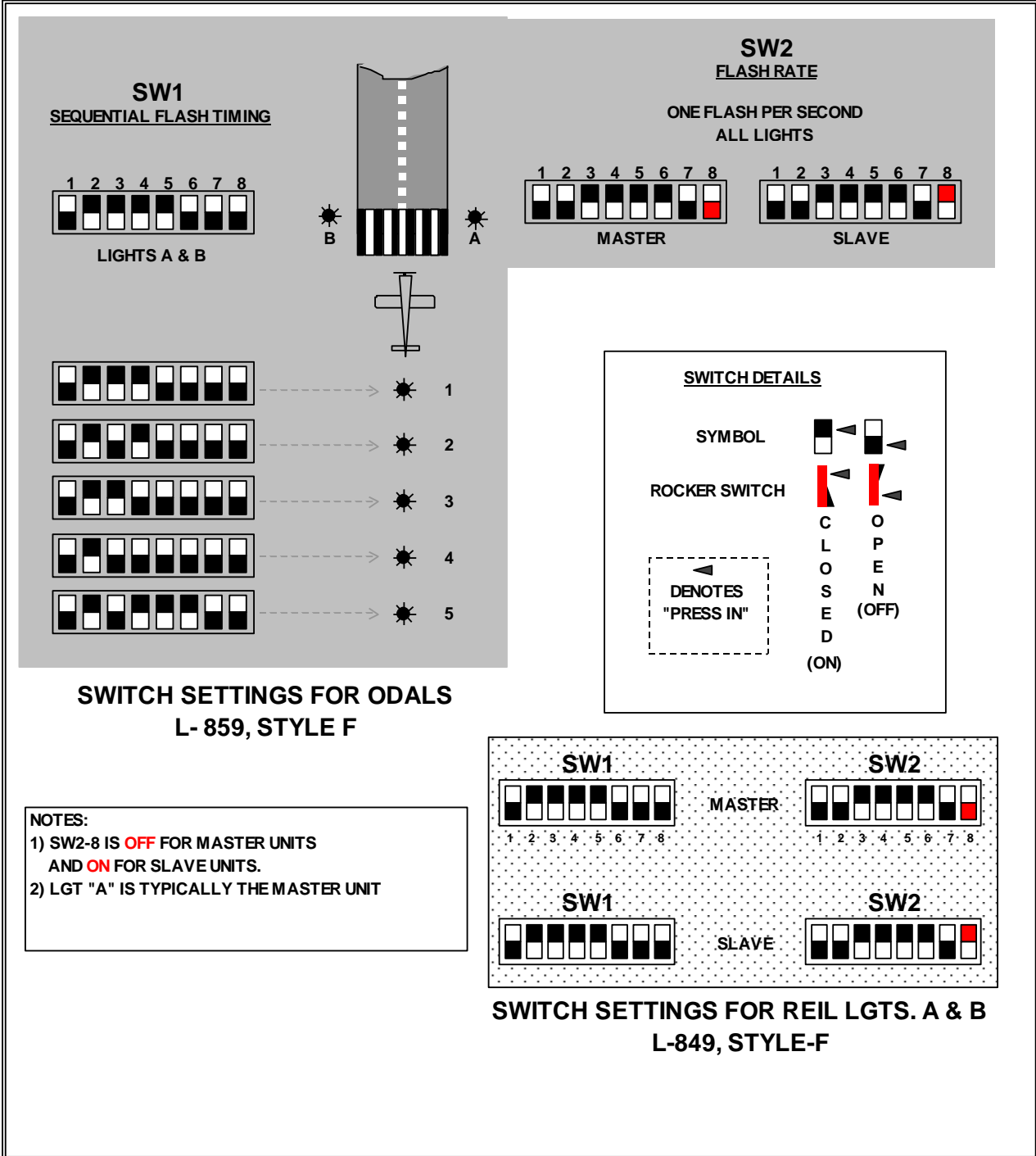

Figure 6
Circuit Board Programming

SET UP PROCEDURES

The equipment is set up at the factory for three levels of intensity while driven by a five-step, pulsed (chopped) waveform CCR, unless it has been ordered for single intensity operation. The tables below show the typical factory settings for three-step and five step CCRs. The flash mode response does not necessarily have to be the same as those shown in the tables. You can customize the response at your site by making new adjustments.

CCR STEP	CURRENT (AMPS)	FLASH MODE
3	6.6	HIGH
2	5.5	MED
1	4.8	LOW

Table 1
Three-Step CCR

CCR STEP	CURRENT (AMPS)	FLASH MODE
5	6.6	HIGH
4	5.2	MED
3	4.1	MED
2	3.4	LOW
1	2.8	LOW

Table 2
Five-Step CCR

It is likely that the switching levels will have to be fine tuned upon installation due to specific conditions at your site such as the type of CCR in use and other loads that may be driven by the same CCR. Adjustments are made at the CSM-112 Current Sensing Module in the Master Unit (Figure 7).

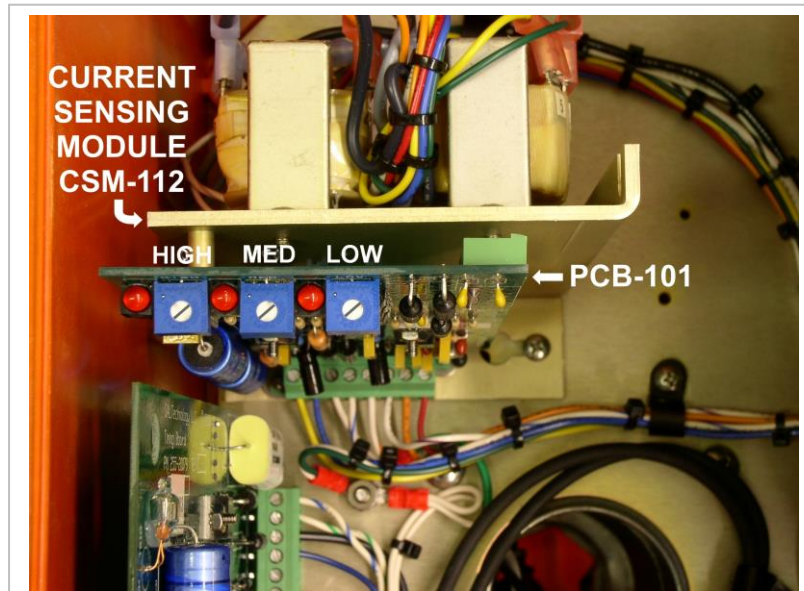

Figure 7
Current Sensing Adjustments

Set Up Procedure for Three Levels of Intensity With a **Three-Step CCR**

THE FOLLOWING INSTRUCTIONS REQUIRE SERVICING THE EQUIPMENT WHILE POWER IS APPLIED. USE APPROPRIATE CAUTION WHILE ACCESSING INTERIOR COMPONENTS.

1. Set the CCR to Step 1 (4.8 amps).
2. Open the cover of the **master** unit, and set the interlock switch to the 'service' position (pull up on the stem of the switch). The unit may or may not begin to flash depending the existing PCB-101 potentiometer adjustments.
3. At PCB-101, (See Figure 7) adjust all three potentiometers, LOW; MED; & HIGH, fully counter clockwise (CCW).
 - If the unit had been flashing it should now turn stop flashing, but PCB-1 (the main circuit board) should still be active.
4. Carefully re-adjust the LOW potentiometer CW until its adjacent LED comes on. Flashing should begin at Low intensity.
 - If the unit fails to flash it may be necessary to proceed to the Troubleshooting section of this manual on Page 15.
5. Set the CCR to Step 2 (5.5 amps).
 - Carefully adjust the MED potentiometer CW until its adjacent LED comes on. The unit should now flash at Medium intensity.
6. Set the CCR to Step 3 (6.6 amps).
 - Carefully adjust the HIGH potentiometer CW until its adjacent LED comes on. The unit should now flash at High intensity.
7. Set the CCR back to Step 2.
 - The HIGH LED should turn off. If it does not, adjust the HIGH potentiometer incrementally CCW until it does. The unit should then flash at Medium intensity.
8. Set the CCR to Step 1.
 - The MED LED should turn off. If it does not, adjust the MED potentiometer incrementally CCW until it does. The unit should then flash at Low intensity.
9. It is advisable to run through the CCR steps once more to verify that switching is correct. Make any necessary adjustments to the potentiometers to achieve correct switching by repeating the steps above.
10. No adjustments are required at a slave unit.

Set Up Procedure for Three Levels of Intensity With a Five-Step CCR

THE FOLLOWING INSTRUCTIONS REQUIRE SERVICING THE EQUIPMENT WHILE POWER IS APPLIED. USE APPROPRIATE CAUTION WHILE ACCESSING INTERIOR COMPONENTS.

1. Set the CCR to Step 1 (2.8 amps).
2. Open the cover to the master unit, and set the interlock switch to the 'service' position (pull up on the stem of the switch). The unit may or may not begin to flash depending on the existing PCB-101 potentiometer adjustments.
3. At PCB-101 (See Figure 7), adjust all three potentiometers, LOW; MED; & HIGH, fully counter clockwise (CCW).
 - If the unit had been flashing it should now stop flashing, but PCB-1 (the main circuit board) should still be active.
4. Carefully re-adjust the LOW potentiometer CW until its adjacent LED comes on. Flashing should begin at Low intensity.
 - If the unit fails to flash it may be necessary to proceed to the Troubleshooting section of this manual on Page 17.
5. Set the CCR to Step 2 (3.4 amps).
 - The LOW LED should remain on and flash intensity should be unaffected.
6. Set the CCR to Step 3 (4.1 amps).
 - Carefully adjust the MED potentiometer CW until its adjacent LED comes on. The unit should switch to Medium intensity flashes.
7. Set the CCR to Step 4 (5.2 amps).
 - The MED LED should remain on and flash intensity should be unaffected.
8. Set the CCR to Step 5 (6.6 amps).
 - Carefully adjust the HIGH potentiometer CW until its adjacent LED comes on. The unit should switch to High intensity flashes.
9. Set the CCR back to Step 4.
 - The HIGH LED should turn off. If it does not, adjust the HIGH potentiometer incrementally CCW until the LED turns off. MED & LOW LEDs should remain on, and the unit should flash at Medium intensity.
10. Set the CCR to Step 3.
 - There should be no change from the conditions in Step 9.
11. Set the CCR to Step 2.
 - The MED LED should turn off. If it does not, adjust the MED potentiometer incrementally CCW until the MED LED turns off. The LOW LED should remain on and the unit should flash at Low intensity.
12. Set the CCR to Step 1.
 - There should be no change from the conditions in Step 11.
13. It is advisable to run through the CCR steps once more to verify that switching is correct. Make any necessary adjustments to the potentiometers to achieve correct switching by repeating the steps above.
14. No adjustments are required at a slave unit.

Set Up Procedure for **Single Intensity** Operation

THE FOLLOWING INSTRUCTIONS REQUIRE SERVICING THE EQUIPMENT WHILE POWER IS APPLIED. USE APPROPRIATE CAUTION WHILE ACCESSING INTERIOR COMPONENTS.

The procedure for single intensity operation is essentially the same for all CCRs whether they are three or five-step regulators (Style 1 or Style 2).

Most single intensity runway approach strobes operate at High intensity, although the system could also be set up for a single intensity of Medium or Low. The level of current required to achieve the full level of a High intensity flash varies with the type of waveform produced by the CCR. Full intensity can be achieved at only 4.8 rms amperes if the CCR waveform is sinusoidal. A minimum of 5.5 rms amperes may be required if the waveform is pulsed. Thyristor (SCR) CCRs produce pulsed waveforms; most others are sinusoidal. Setting the system to operate at the lowest permissible level of current reduces the strobe system load on the Series Lighting Circuit.

For single intensity, **High** intensity operation:

1. Set the CCR to the level of current at which you want HIGH intensity flashing to begin (minimum of 4.8 or 5.5 amperes, depending on the CCR Style).
2. Open the cover to the master unit, and set the interlock switch to the 'service' position (pull up on the stem of the switch).
3. At PCB-101, (See Figure 7) adjust the HIGH potentiometer fully clockwise, and LOW & MED potentiometers fully counter clockwise (CCW).
 - If the unit had been flashing it should now stop flashing, but PCB-1 (the main circuit board) should still be active.
4. Now carefully adjust the **LOW** potentiometer CW until its adjacent LED comes on. Flashing should begin at High intensity.
5. Do not adjust the MED potentiometer. It must remain in the fully CCW position.
6. Do not adjust the HIGH potentiometer. It should be left in the fully CW position.
7. Set the CCR (whether 3-step or 5-step) to the next lower step. The LOW LED should extinguish, and the strobe should stop flashing. If it does not, adjust the **LOW** potentiometer incrementally CCW until it does.
8. Test the adjustments by observing the results as the CCR is switched from one step to another, and make any necessary re-adjustments to the LOW potentiometer.
9. No adjustments are required at a slave unit.

Contact the factory for other custom flash control conditions.

THEORY OF OPERATION

A xenon capacitive discharge light is often referred to as a “strobe”. A flash is produced when sufficient electrical energy is abruptly ‘dumped’ into a lamp filled with xenon gas. The gas, which is normally nonconductive, must be brought to a conductive state for a flash to occur. This requires applying a pulse of high amplitude (a triggering pulse) to the lamp. The energy producing the flash is stored in a bank of capacitors connected to the lamp electrodes. The capacitors, charged to a relatively high potential, discharge through the lamp when the internal gas becomes conductive.

SAL Technology® strobes consist of two major subassemblies called power supplies and flash heads. A power supply converts external ac primary power to dc (direct current) that is fed to a bank of energy storage capacitors bringing them to a charge potential of about 1000 Volts dc (± 500 Volts).

Most runway approach strobes must be capable of 3 levels of flash intensity—High, Medium, and Low. Flash intensity levels are changed by switching the lamp to different values of bank capacitance.

Flash head components consist of a sealed-beam xenon lamp, a triggering transformer, and additional minor circuitry. The flash head is connected to the power supply by a short harness if it is co-mounted or by a cable when it is installed remotely. The harness/cable connects the bank of capacitors in the power supply to the anode and cathode flash lamp electrodes. The maximum voltage on the anode conductor is +500 Volts dc. The maximum voltage on the cathode conductor is –500 Volts dc. The total lamp voltage at discharge is therefore 1000 volts. The harness/cable also carries a low level triggering pulse that is applied to a small transformer in the flash head where it is boosted to a voltage level high enough to trigger the flash lamp into its conductive state. A coupling transformer located in the power supply provides an intermediate signal boost that improves triggering when a very long flash head cable is used.

A REIL system has two lights that flash simultaneously. Some approach lighting systems have as many as 21 lights that flash sequentially. The practical limit for SAL Technology® sequential flashers is even higher. The point is that these lights must always operate as an integrated system. This requires a form of communication between the lights. The method used in SAL Technology® systems is an encoded signal that is distributed by an interconnecting control line. The encoded signal carries timing and flash intensity information that originates at a master unit. The only difference between a master unit and a slave unit is an internal control module residing in the master unit. The control module monitors the current in a Series Lighting Circuit and provides adjustments for setting intensity switching thresholds at specific levels of SLC current.

MAINTENANCE

SAL Technology® approach lights require only minimal maintenance.

Every 6 months

- Make sure that the cover latches are secured and holding the cover tightly closed.
- Check the venting plug on the bottom of the power supply, and clear the breathing holes if they have become clogged.
- Check screw tightness on TB1 and TB3 (8-position terminal blocks; See Figure 9 for locations). Check every position that has a wire connection whether to external wiring or to internal circuits.
- Check co-mounted flash head sealing. There should be a continuous bead of sealing compound between the housing hub and the EMT compression nut as shown in Figure 8a. Sealing compound must also be packed all around the harness sleeve as shown in Figure 8. Use Gardner-Bender DS 110, or similar, Duct Seal when repairing or replacing.

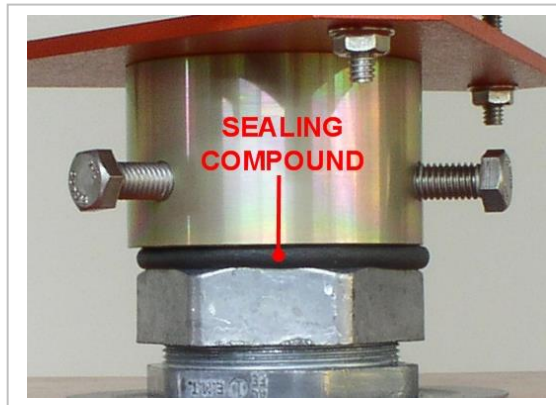

Figure 8

Annually:

- Check the neoprene cover gasket on the power supply enclosure for nicks or tears. If repair is needed use a neoprene compatible adhesive. RTV may not adhere well to the neoprene gasket.
- Perform a mode switching response check. Verify the lights respond correctly to all commands from the SW101 Control Switch in the master unit.
- Verify that the flash rate is correct (60 flashes per minute).
- Verify that the threshold lights flash simultaneously, and that sequenced lights flash in the correct order.

TROUBLESHOOTING

Some problems affect only one light while other problems may affect part or all of an entire system. Most problems occur at initial turn on. This is primarily because the control line is the only untested part of a newly installed system. Control line problems usually affect not just one, but all, of the lights in a system. It is, however, possible for only one light to be affected if a programming switch was bumped while working in a power supply during electrical hookup causing it to become unintentionally reprogrammed.

Faults that may arise after a system has been working properly are usually due to rather predictable causes brought on by component aging, deferred maintenance, or perhaps some type of damage. These problems usually affect only one light, although there can be exceptions.

It is important to know where the major components are located, especially when attempting to follow troubleshooting procedures. Use Figures 9 and 10 for this information. A slave power supply does not have a CSM 112 Current Sensing Module; it is otherwise identical to a master power unit.

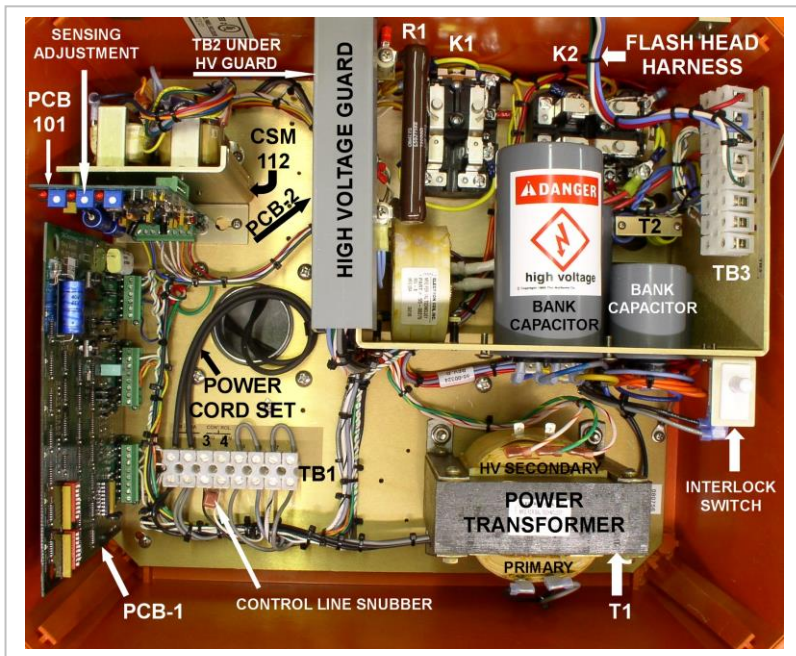

Figure 9
Master Power Supply Component Identification

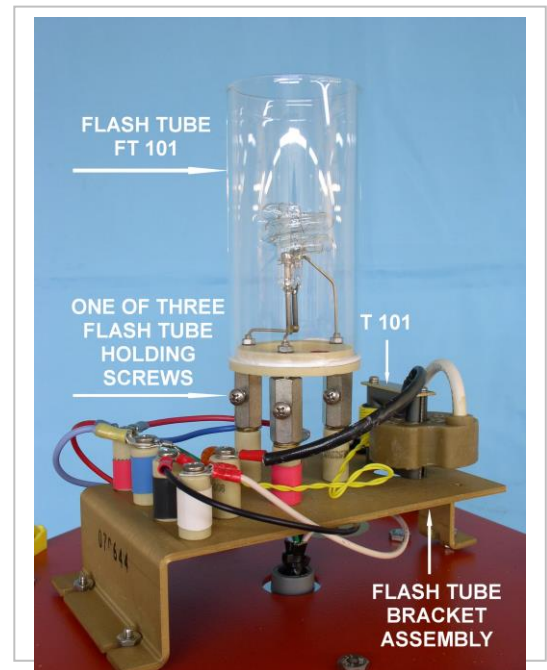

Figure 10
Flash Head Internal Components

TROUBLESHOOTING-STATUS LIGHTS

Each power supply has two circuit boards with indicator lights that can be used to interpret operating conditions. PCB-1 is the Timing and Control circuit board. Its location is shown in Figures 9 & 15. It has seven red LEDs, but only five of these apply to standard functions. DS1 and DS2, labeled Monitor and Confirm, are used only when the Monitoring option has been elected at the time of purchase. SW1 and SW2 are programming switches. SW1 and SW2 are programming switches.

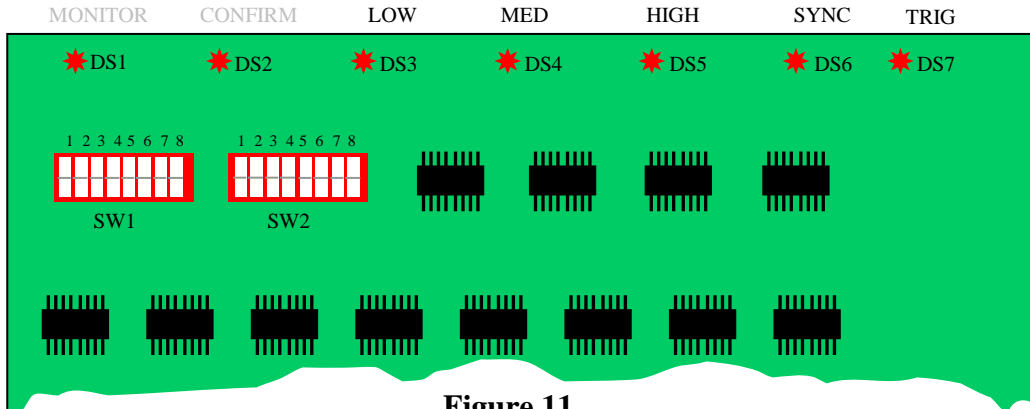

Figure 11
PCB-1 Status Functions

PCB-2 (High Voltage Rectifier Board) does not show in Figure 12, but its location beneath the High Voltage Guard is noted. Two LEDs, DS1 & DS2, on PCB-2 (Figures 9 & 15) are in prominent view for safety and troubleshooting. These LEDs are high voltage indicators, and both must be lit for normal operation. They will extinguish soon after power is removed. Many older PCB-2 circuit boards have neon lamps for DS1 & DS2.

Do not touch any circuit component within the power supply or flash head when the LEDs are lit.

The full bank voltage is 1000 volts dc. This is a dangerous potential—Use appropriate caution!

NOTE:

There is no interlock switch in an FHUD-109 flash head.

Always turn off and lock out the power supply when accessing the flash head.

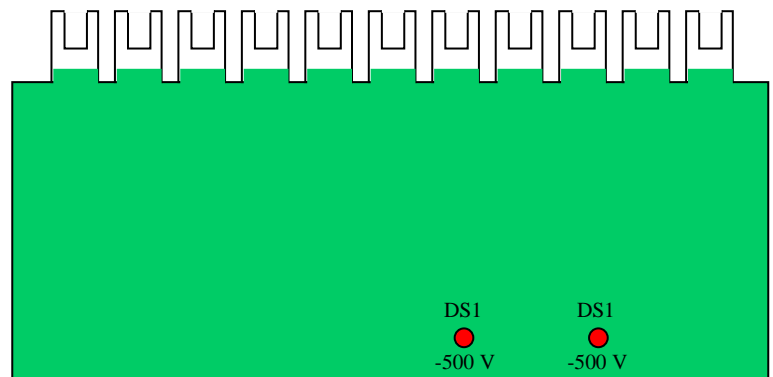

Figure 12
Status and Safety LEDs

TROUBLESHOOTING–NORMAL INDICATIONS

Effective troubleshooting does not necessarily require measuring instruments. Most problems can be identified by audio and visual techniques, but first one must know what to look and listen for as the equipment operates. When a light is working properly there will be characteristic sounds and circuit board status light conditions. Recognizing the absence of any normal indication is the first step in tracking down the cause of a malfunction. To use sight and sound diagnostically you should know what to look and listen for in normal operation.

With power applied, the interlock switch set to the service position (plunger pulled upwards), and the CSM-112 properly adjusted, a unit that works correctly will flash steadily at a rate of 120 FPM. The flash intensity will depend on the level of current in the Series Lighting Circuit and how the CSM-112 in the master unit was set up.

Note that a light set up to flash only at High intensity has a minimum current requirement. Stated another way, the input current from the Series Lighting Circuit must be high enough to support operation at High intensity. Refer to the “Set up Procedure for single intensity flashes” and Tables 1 & 2 for more information.

Diagnostics by sight and sound:

- There will be an audible “buzz” from the T1 power transformer.
- There will be an audible “thump” accompanying each High intensity flash as the capacitors discharge through the lamp. This discharge thump may not be noticeable for Medium or Low intensity flashes.
- There will be a sharp, audible snap coinciding with each Medium and Low intensity flash if the flash head is co-mounted. The snap is from the triggering circuit in the flash head. At High intensity the snap is likely to be completely masked by the louder discharge thump. The snap may not be noticeable if the flash head is remotely mounted from the power supply.
- DS7 is lit when triggering voltage is present.
- If DS7 is a neon lamp it will ‘wink’ out with each flash.
- If DS7 is an LED it will stay on steady if triggering voltage is present.
- DS6 will blink at the same rate as flashing, but does not quite coincide with the flashes.
- In High mode, DS5, DS4, & DS3 will be on steady.
- In Medium mode, DS 5 & DS4 will be on steady, and DS3 will be off.
- In Low mode DS5 on will be on steady*; DS3 & DS4 will be off.
*DS3 will blink rapidly if the system is setup for single intensity only AND the CCR current is below the “turn-on” threshold set at the master unit. DS3 should never blink if the set up is for 3 flash intensities unless there is significant electrical interference being picked up on the control line between the master and slave units.

An exception to any of the above conditions is the first troubleshooting clue. Procedures for identifying the cause of a problem are broken down into categories to speed up troubleshooting. The broadest category is whether the problem is occurring at initial turn-on of the system or after the system has previously worked correctly. The next category is whether the problem affects one light only or appears to be a system problem affecting all or most of the lights. Possible causes are generally listed according to estimated probability.

I. PROBLEMS OCCURRING AT INSTALLATION

The most common problems when a system is first turned on are:

1. Flashing at the wrong intensity or Erratic Flashing.
2. No Flash at all.

Erratic Flashing is the term used when a light skips flashes or toggles from one intensity to another as it flashes.

Erratic flashing that affects an entire system could be caused by sporadic intensity changes that could appear as missed flashes when viewed from a distance.

These problems would typically affect all of the lights the same way, but there can be exceptions.

A. When all of the lights are affected:

1. Flashing at the Wrong Intensity or Erratic Flashing

a) Borderline threshold adjustments.

- Repeat the set up procedure at the CSM-112 Current Sensing Module in the master unit.

b) Electrical interference on the control line.

- Disconnect the control line at TB1, Terminal 3 in the master unit. If the master unit then works properly reconnect the control line, and remove the control line from TB1, Terminal 3 in the slave unit. If the slave unit then works properly, the problem is being caused by interfering signals on the control line. See control line requirements below.

2. No flash at all

Severe interference on the control line could prevent flashing altogether.

Control line requirements:

The control line wires must be twisted together. Shielding is not necessary or recommended. Shielding is not a substitute for twisting. If the control line consists of two wires twisted together inside of a surrounding shield, it might help to disconnect the shield at both ends. A control line problem can usually be further verified by temporarily laying a substitute line (twisted) on the surface between the master and slave units.

B. When only one light is affected:

No flash or flashing at the wrong time

- This is an unusual condition at initial turn on. If it does happen it is most likely because a programming switch on PCB-1 was unintentionally bumped and reprogrammed while working inside the power supply during installation. Correct programming information can be found in Figure 6 and also on the inside of the power supply cover for the unit affected.
- It is also possible that the equipment was somehow damaged after leaving the factory.
- If the flash head is located remotely from the power supply, the cable could be incorrectly hooked up.

II. EVOLVING PROBLEMS (When a Light Stops Working Correctly)

Most problems that develop after a system has been working correctly affect only one light. A notable exception may arise if other loads have been added or removed from a Series Lighting Circuit that is shared with the strobe system, or if the CCR has been changed. Re-adjusting the CSM-112 thresholds will usually restore correct operation.

Most problems affecting only one light fall in one of the following categories:

- A. No Flash
- B. Wrong Intensity
- C. Skipping Flashes

The method of fault isolation prescribed below consists mainly of following the tips leading to a specific component, and verification by temporarily exchanging that component with one known to be working correctly.

A. No Flash

1. No High Voltage, evidenced by DS1, DS2, & DS3 on PCB-2 not being lit:
 - a) PCB-2 defective.
 - b) T1 Power Transformer defective.

Caution: Do not disconnect the wires to the secondary winding of the transformer to check for a shorted load. A short circuit on the secondary winding will prevent high voltage but will not harm the transformer. However, an open circuit on the secondary winding will destroy the transformer when power is applied.

- c) Bank capacitor shorted. Call 1.315.682.6460 for assistance.
2. No Trigger, evidenced by no audible ‘snap’ in Low or Medium mode:
 - a) Change PCB-1 if DS7 is on steady.
 - b) Change PCB-2 if DS7 on PCB-1 is not lit—then change PCB-1 if DS7 remains unlit.
 - c) Change T101 (trigger transformer in flash head) if the problem is yet unresolved.
3. Defective flash Lamp
Change out the flash lamp.

EVOLVING PROBLEMS, Cont.

B. Wrong Intensity

1. DS5, DS4, or DS3 do not agree with the LED mode indications at the CSM-112 Controller:
 - a) Change out PCB-1.
 - b) Change out PCB-101.
2. DS5, DS4, & DS3 agree with the CSM-112, yet the flash intensity is wrong:
 - a) Check K1 & K2 for correct switching responses as shown in Table 3 below.

Table 3, Mode Relay Conditions

RELAY	IN*	OUT	INTENSITY
K1		√	LOW
K2		√	
K1		√	MED
K2	√		
K1	√		HIGH
K2	√		

* IN means the relay is 'pulled in', that is, energized.

C. Skipping Flashes

When a flash lamp skips flashes it is probable that either the flash lamp or the trigger transformer is approaching failure. To pin down which one:

- a. Turn off the power. Power is automatically turned off when the power supply cover is opened. Do not pull up the stem of the interlock switch to the service position.
- b. Disconnect the RED wire from TB3 in the power supply (be sure DS3 on PCB-2 is not lit).
- c. Apply power (pull up on the interlock switch plunger).
- d. Listen for trigger snaps as mentioned earlier.
- e. Change out the T101 trigger transformer if trigger skipping is detected.
- f. Change out the flash lamp if the trigger does not skip.
- g. Replace the RED wire to TB3 and tighten the terminal block screw firmly.

FLASH HEAD COMPONENTS REPLACEMENT

The following instructions apply to replacing major flash head components. It is necessary to remove the lens to gain access to these components. Access instructions are on Page 2 of this manual.

Be sure to read the instructions on Page 2 for re-installing the lens.

1. FLASH TUBE (Figure 13a)

The flash tube is held by a pin and socket arrangement. The pins are anchored in the ceramic base of the flash tube. The sockets are part of the flash tube bracket assembly, and provide mechanical as well as electrical functions. Each socket has a Phillips head set screw that engages the flash tube pin. These setscrews are shown in Figure 13b.

CAUTION

A replacement flash tube is shipped with foam packing wedges inserted between the tube helix and the outside cylinder. These wedges must be removed when the flash tube is installed.

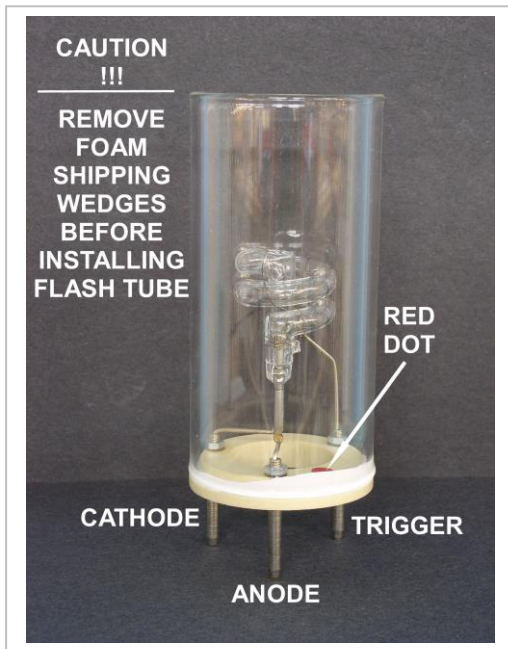

**Figure 13a
Flash Tube**

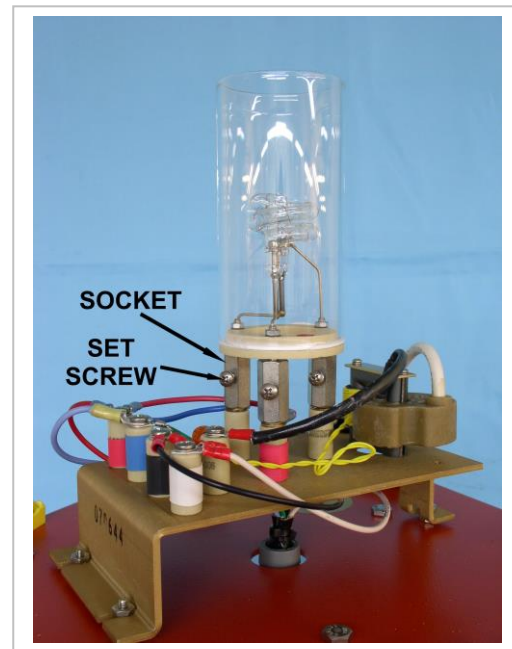

**Figure 13b
Flash Tube Bracket**

Removal:

Loosen, but do not remove, the three setscrews holding the flash tube.

- Lift the flash tube straight up until the three electrode pins are free of their sockets.

b) Replacement:

One of the flash tube electrode pins (the anode) is identified by a red dot on the inside surface of the ceramic base. This pin must be inserted into the socket identified by a red band around the insulating post to which it is attached.

- Insert the flash tube into the sockets until it is firmly seated against the top surfaces of all three of the sockets.
- Tighten the three setscrews snugly.

2. TRIGGER TRANSFORMER HV COIL

The trigger transformer is an open frame device consisting of a primary coil, a potted high voltage (HV) coil, a ferrite core, and assembly hardware. The entire assembly is held to the flash tube bracket by two 4-40 Phillips head screws. It is generally unnecessary to replace the entire transformer assembly if a problem develops. A kit (PN 255-20027) is available for field repair.

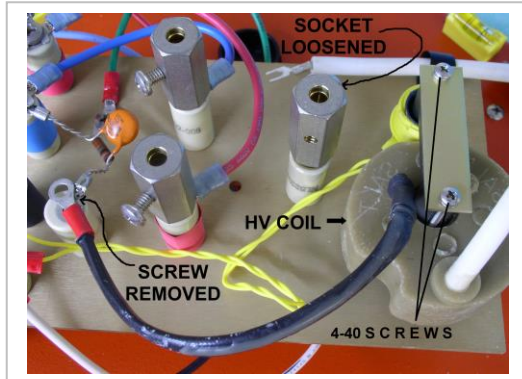

Figure 14a
HV Coil Removal

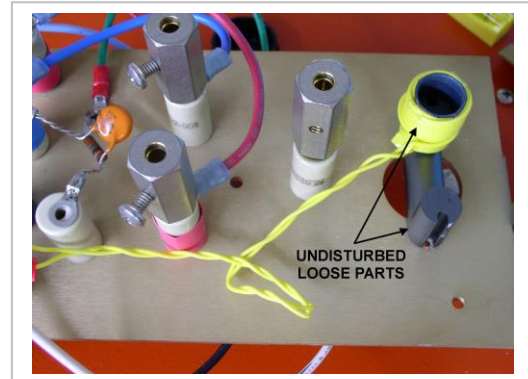

Figure 14b
T101 Partial Assembly

Removal:

- Loosen the setscrews identified in Figure 13b, and remove the flash tube.
- Loosen the hex socket identified in Figure 14a. It may be necessary to grip the ceramic post with pliers in order to loosen the socket.
- Detach the large white wire from the HV coil to the hex socket just loosened.
- Remove the terminal screw that secures the black wire from the HV coil identified in Figure 14a
- Remove the “P” clamp screw that secures the white HV lead to the flash tube chassis.
- Remove the two 4-40 screws and the flat plate identified in Figure 14a.
- Carefully lift the top half of the ferrite core away.
- Lift the HV coil from the bottom half of the ferrite core and try to leave the rest of transformer parts in place as shown in Figure 14b.

b) Replacement:

- Install the replacement HV coil over the bottom half of the ferrite core with the white HV lead positioned in the same manner as the original.
- Insert the upper half of the ferrite core down through the center of the HV coil and the spool that holds the primary coil.
- Re-install the small flat plate and the long 4-40 screws.
- Tighten the screws symmetrically—alternating from one to the other until the two screws begin to tighten.
- **Be very careful when-tightening these screws. Over-tightening can fracture the ferrite core.**
- Reattach the white wire to the hex socket identified in Figure 14a, and lightly tighten the socket to the insulating post.
- Reattach the black wire from the HV secondary coil to the ceramic insulating post also identified in Figure 14a.
- Re-install the flash tube and tighten the three setscrews that hold it.
- Re-install the lens (See the instructions on Page 2).

Table 4, Replaceable Parts

REF	DESCRIPTION	PN
A-100	Flash Head Bracket Ass'y (See Figure 10 & 13a)	255-20248
C1	Bank Capacitor, 40 μ f	55-00106
C2, C3	Bank Capacitor, 20 μ f	55-00107
C4	Bank Capacitor, 5 μ f	55-00110
C5	Bank Capacitor, 4.5 μ f	55-00111
FT 101	Flash Tube (See Figure 13a)	55-00360
K1, K2	Relay, Mode Switching	55-00193
PCB-1	Printed Circuit Board, Timing & Control	255-20079
PCB-2	Printed Circuit Board, High Voltage Rectifier, Type I	255-20082
PCB-101	Printed Circuit Board, Current Sensing (See Figure 9)	255-20086
P1, P2	Ceramic Standoff, 1 inch, (for R1, See Figure 15)	55-00200
R1	Capacitor Bleed Resistor, 75 k Ω , 50 W	55-00228
S1	Interlock Switch	55-00201
T1	Power Transformer, High Voltage; 50/60 Hz.	55-00005
T101	Trigger Transformer Kit	255-20027
TB1, TB3	Terminal Block, 8 Position	55-00146
TB2	Terminal Block, 11 Position (for PCB-2)	55-00273

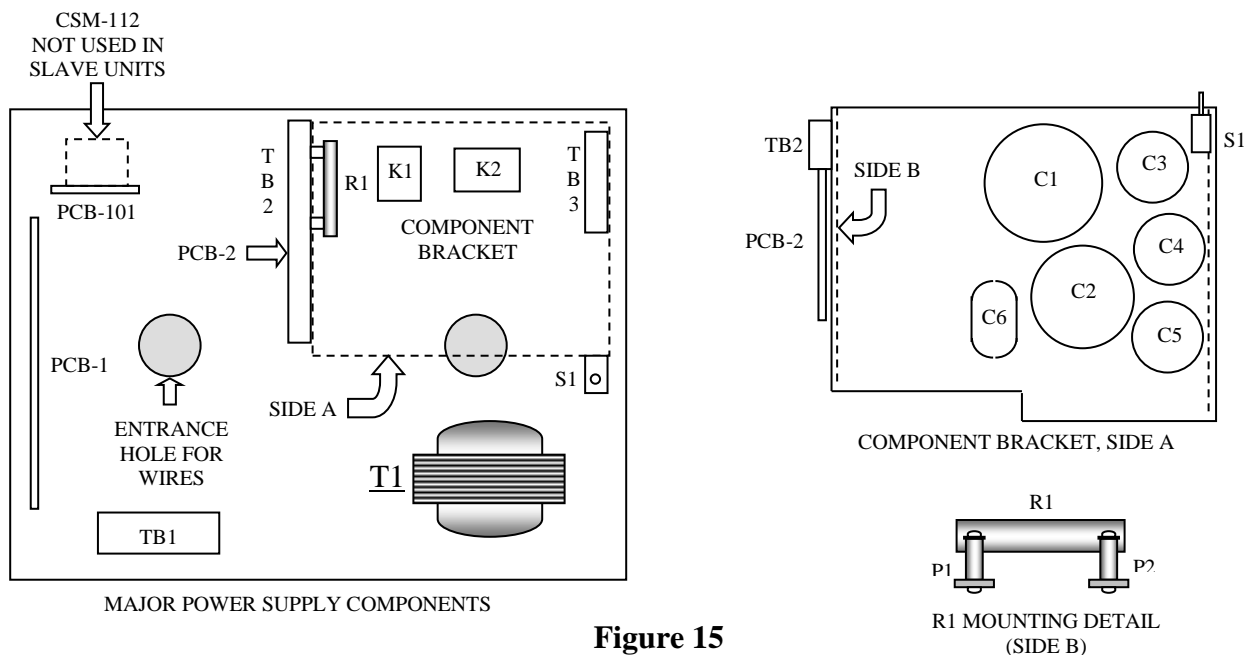

**Figure 15
Component Location Diagrams**