

# STROBE APPROACH LIGHTING TECHNOLOGY

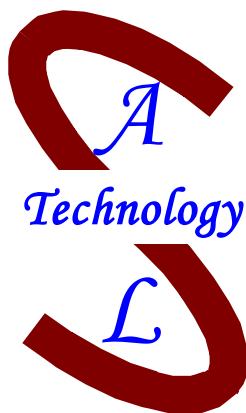
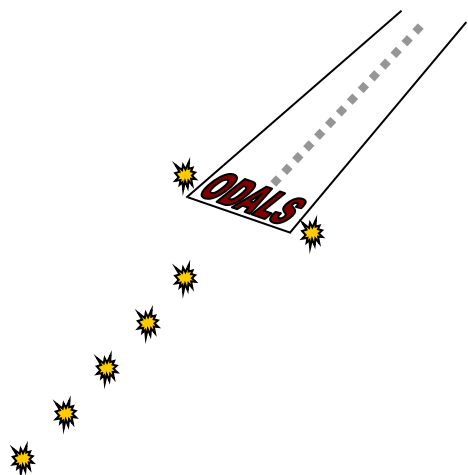
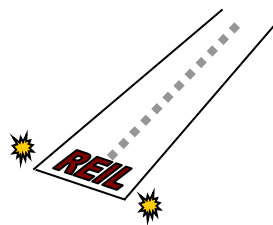

## OMNI-DIRECTIONAL VOLTAGE-POWERED APPROACH LIGHTING SYSTEM

L849 B/F, L859

USER'S MANUAL

MAN-AL03 Rev 1.3

STROBE APPROACH LIGHTING TECHNOLOGY™  
108 Fairgrounds Drive Manlius NY 13104  
603-598-4100



## **SCOPE**

This manual contains Installation, Operation, and Maintenance information for Voltage-Powered Omnidirectional Runway Approach Lights manufactured by Strobe Approach Lighting Technology™ (SAL Technology™), Manlius, NY, USA.

## **CARTON LABELING**

Each carton contains one complete light consisting of a power supply and a flash head. If your system consists of two lights (i.e., an L-849, Style F system), one carton will be labeled Master and the other labeled Slave.

If your system consists of seven lights (ODALS, L-859, Style F) the carton containing the master unit will be labeled as Master, Light A. Another carton will be labeled as Light B. The remaining cartons will be labeled as Light #1, Light #2, and so on. The placement of these lights is shown in Figure 6 of this manual.

Some systems may have accessory items that require separate packaging. Those packages are also appropriately identified.

In addition to a power supply and flash head, each carton contains two frangible fittings with short EMT couplings for power supply installation. An Owner's Manual is included in the carton containing the master unit.

## **UNPACKING**

Inspect each shipping carton for external damage immediately upon receipt. There could be damage to the contents if the carton is damaged. Promptly file a claim with the freight carrier if you have received damaged equipment.

## **TOOLS REQUIRED**

#2 Phillips screwdriver; 10-inch shank.

1/4-inch, flat blade screwdriver; 10-inch shank.

1/8-inch, flat blade screwdriver; short shank (for circuit board potentiometer adjustments).

Water pump pliers opening to 3-inches (for 2-inch EMT compression fittings).

Wire strippers.

Wire cutters (for small gage wire).

Spirit or digital level (for leveling a co-mounted power supply).

Volt-Ohm meter; 1000-volt range.

## **ABBREVIATIONS USED IN THIS MANUAL**

PSOV → Power Supply Omni-directional Voltage

FHOD → Flash Head Omni-Directional

ODALS Omni-Directional Approach Lighting System

REIL → Runway End Identifier Lights

SLC → Series Lighting Circuit

NPT → National Pipe Tapered (thread)

EMT → Electrical Metallic Tubing

## **DISCLAIMER**

The information in this manual is believed to be accurate and up to date, however, Strobe Approach Lighting Technology™, assumes no liability for damages or injuries that may result from errors or omissions, or from the use of information presented herein. Strobe Approach Lighting Technology reserves the right to modify this manual at its discretion without notification to any person or organization.

## **APPLICABLE SPECIFICATIONS**

This equipment meets or exceeds the requirements in the FAA Advisory Circular, AC 150/5345-51A, and is listed as FAA approved equipment in AC 150/5345-53, Addendum B.

## **WARRANTY**

Strobe Approach Lighting Technology warrants that this equipment has been manufactured and will perform in accordance with applicable specifications and that any defect in design, materials, (excluding lamps,) or workmanship which may occur during proper and normal use during a period of 1 year from date of installation or at least 2 years from date of shipment will be corrected by repair or replacement by the manufacturer FOB factory.

## **USE OF GENERIC PARTS**

Using parts not manufactured or supplied by Strobe Approach Technology, or unauthorized modification of any part of this equipment, voids the warranty and could render the equipment noncompliant with applicable FAA specifications.

## **CONTACT INFORMATION**

Strobe Approach Lighting Technology may be contacted by the following methods:

Tele: 1-603-598-4100

Fax: 1-603-598-4198

Email: sales@saltechnology.com

## **WARNING**

### **Dangerous Voltages**

This equipment generates voltages that are dangerous to personnel. Use appropriate caution while operating or servicing this equipment.

Capacitors can retain a substantial charge even after power has been removed. Allow at least one minute after turning off the power for the capacitors to be drained of charge—then check the safety lamps inside provided for this purpose.

### **Do Not Depend on Interlocks**

Never depend on an interlock switch alone to render the equipment safe. Always look for the condition of the **High Voltage Indicating Lights** and check circuits with a voltmeter.

Do not disable the safety interlock switch.

## **TABLE OF CONTENTS**

	<b>Page</b>
Front Matter -----	i-iv
Carton Labeling -----	i
Unpacking -----	i
Tools Required -----	i
Abbreviations Used In This Manual -----	i
Applicable Specifications -----	ii
Warranty -----	ii
Use of Generic Parts -----	ii
Contact Information -----	ii
Table of Contents -----	iii
List of Figures -----	iv
List of Tables -----	iv
General Description -----	1
Access -----	2
Installing a Flash Head Lens -----	2
Equipment Specifications -----	3
Installation -----	4-9
Mounting the Power Supply -----	4
Primary Power Hookup -----	5, 6
Control Line Hookup -----	7, 8
Remote Control Hookup -----	9
Functional Description -----	10
Applications -----	10
Circuit board Programming -----	11
Operation -----	12
SLC Control -----	13-16
Setup Procedures -----	13
Three Levels of Intensity From a 3-Step CCR -----	14
Three Levels of Intensity From a 5-Step CCR -----	15
Single Intensity Setup -----	16
Theory of Operation -----	17
Maintenance -----	18
Troubleshooting -----	19-24
Status Lights -----	20
Normal Indications -----	21
Problems At Installation -----	22
Evolving Problems -----	23, 24
Replacing Flash Head Components -----	25-26
Flash Tube -----	25
Trigger Transformer -----	26
Replaceable Parts -----	27

<b><u>LIST OF FIGURES</u></b>	<b>PAGE</b>
1a: Power Supply -----	1
1b: Flash Head -----	1
1c: Co-mount -----	1
1d: Lens Details-----	2
1e: Lens Clamp Details -----	2
2: Power Supply Mounting Details -----	4
3: Installation Wiring Guidelines -----	5
4: TB1 Labeling-----	6
5: Control Line Connections -----	7
6: System Installation Wiring Diagram -----	8
7: Remote Control Switch Circuit -----	9
8: Optional Series Circuit Hookup -----	9
9a: PCB-1 Photo -----	10
9b: Programming Switches Detail -----	10
10: Circuit Board Programming -----	11
11a: Control Module -----	12
11b: Optional Module For Current Sensing-----	12
12: Co-mounted Flash Head Sealing -----	18
13: Power Supply Component Identification -----	19
14: Flash Head Component Identification -----	19
15: PCB-1 Status Lights:-----	20
16: PCB-2 Status and Safety Lights: -----	20
17a: Flash Tube -----	25
17b: Flash Tube Bracket -----	25
18a: HV Coil Removal (T101) -----	26
18b: T101 Partial Assembly -----	26
19: Component Location Diagrams -----	27

<b><u>LIST OF TABLES</u></b>	
Table 1: Three-Step CCR -----	13
Table 2: Five-Step CCR -----	13
Table 3: Relay Mode Conditions -----	24
Table 4: Replaceable Parts -----	27

## GENERAL DESCRIPTION

A flashing runway approach light from SAL Technology consists of a power supply and a flash head. The power supply (Figure 1a) may be either a master unit or a slave. The catalog designation for a Master Power Supply is PSOV-105. A Slave Power Supply is PSOV-106. The Flash Head (Figure 1b) in either case is FHOD-110. The flash head may be attached directly to a power supply enclosure (co-mounted) as in Figure 1c or installed separately, and connected by up to 100 feet of suitable cable. This equipment is classified as an omni-directional discharge flasher (strobe) that operates from 120 or 240 V, 60 Hz (specify when ordering). It can also be provided to operate at 230 Volts, 50 Hz

It is specifically designed and tested to meet the requirements for L-849V, Styles A & F (REIL), and L-859V, Style F (ODALS), as defined in the FAA's "Specification for Discharge-Type Flashing Light Equipment", AC 150/5345-51A.

L-849V and L-859V are designations used by the FAA for voltage-powered flashing lights for runway approach lighting applications.

L-849V and L-859V lights from SAL Technology are certified by third party testing under the FAA's Airport Lighting Equipment Certification Program (ALECP).



Figure 1a, Power Supply



Figure 1b, Flash Head



Figure 1c, Co-mounted Unit

## ACCESS

The power supply cover is secured by quarter-turn latches on the two front corners of the enclosure. These latches may be padlocked for security. A co-mounted unit also has two self-releasing latches across the hinge. The hinged cover when fully opened is supported by a lanyard.

Access to flash head components requires removing the lens which is held to the base plate by six clamps secured by screws. Loosen but do not remove the screws, and then lift the lens straight up from the base and set it aside. The flash head does not have to be accessed for installation, even if it is mounted separately.

## **CAUTION**

***Follow Instructions for Proper Re-installation of the Lens.***

## RE-INSTALLING THE FLASH HEAD LENS

Three tabs or “feet” extend beyond the lower body of the lens. **Although the lens rests on these tabs they are not used to secure the lens to the baseplate.** These tabs must, however, be properly positioned in order to clear other objects attached to the base plate (See Figure 1d). A positioning guide is provided in the form of an outline of one of the tabs. Locate any one of the tabs within the outline provided, and secure the lens as described below.

After the lens has been properly positioned on the base plate each clamp can be loosely engaged into the **first lens groove** as shown in Figure 1e. Starting with any clamp, lightly tighten it and then skip to the one opposite. Proceed around the lens in this manner until all of the six clamps are lightly tightened. Be sure that the lens clamps are fitted into the first groove above the base plate. Now repeat the tightening pattern, and this time firmly tighten each one.

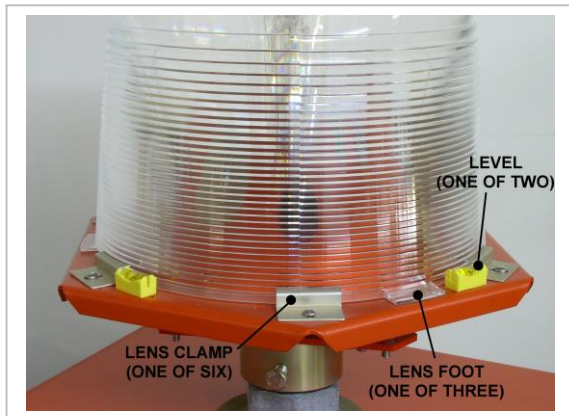

Figure 1d  
Lens Details

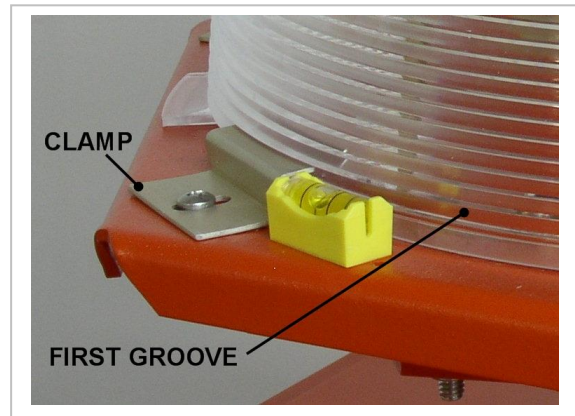

Figure 1e  
Lens Clamp Detail



## EQUIPMENT SPECIFICATIONS

**PHYSICAL:** Dimensions are in inches (mm); Weight in lbs (kg).

**PSOV-105, Master Power Supply**, (Figure 1a).

Dimensions -----8H x 16W x 14D (203 x 406 x 356)  
Weight: -----52 (23.6)

**PSOV-106, Slave Power Supply**, (Figure 1a).

Dimensions -----8H x 16W x 14D (203 x 406 x 356)  
Weight: -----47 (21.3)

**FHUD-110, Flash Head**, (Figure 1b).

Dimensions: -----15H x 13.5 Dia. (381 x 343)  
Weight: -----8.4 (3.8)

**PSOV-101, Master Power Supply**, (Co-mounted, Figure 1c).

Dimensions: -----19.5H x 16W x 14D (495 x 406 x 356)  
Weight: -----60.4 (27.5)

**PSOV-102, Slave Power Supply**, (Co-mounted, Figure 1c).

Dimensions: -----19.5H x 16W x 14D (495 x 406 x 356)  
Weight: -----51.5 (23.3)

### **OPERATIONAL:**

Voltage (rms) -----120 or 240 Volts, 60 Hz  
230 Volts, 50 Hz

Power: (Watts) -----150 Ave, 290 Peak

Flashes Per Minute -----60

Intensity: (Effective Candelas, total beam spread) High: 2500 to 7500  
Med: 750 to 2250  
Low: 150 to 450

Beam Spread: -----360° Horizontal, 10° Vertical.

### **AVAILABLE OPTIONS:** (Must be factory installed)

Remote Control by a Series Lighting Circuit

Flash Monitoring

Elapsed Time Meter

## INSTALLATION

Installation consists of mounting the power supply onto previously prepared supports and making electrical connections. Some installation details could depend on site drawings and specifications originated by others. Basic requirements are given below.

If you are installing a system with sequentially flashing lights you should place each light in its assigned position. Lights identified as A & B are meant to be installed at the runway threshold. Light #1 is a centerline indicating light intended to be nearest to the runway threshold. Light #2 is intended to be next, and so on. A light that has not been placed in its intended position can be re-programmed using the information in Figure 10.

### MOUNTING THE POWER SUPPLY

The power supply requires two, 2-inch NPT base supports at ground level such as NPT flanges anchored in concrete at a spacing of 8.00 inches center to center, or a burial can cover with threaded entrance holes at the required spacing.

The power supply itself is provided with two attached, 2-inch, EMT compression fittings. Frangible fittings shipped with the equipment have male threads at one end and 2-inch EMT compression fittings at the other. Each one is furnished with a short (2-½ inch) length of EMT by which they may be coupled to the compression fittings on the bottom of the power supply enclosure.

The frangible fittings must first be screwed into the ground supports and securely tightened. The EMT couplings must be adjusted to extend out of the frangible fittings by ¾ to 1-inch and the compression nuts securely tightened. Set the power supply down over the two EMT couplings and securely tighten the compression nuts.

A power supply with a co-mounted flash head meets the maximum height restriction set by the FAA when installed as described above and as shown in Figure 2. The 2-½ inch long EMT sections may be replaced by slightly longer sections if local conditions require raising the elevation of the light source by a few inches. This is not recommended for a substantial increase in light center elevation; mounting the flash head on a separate support while leaving the power supply close to the ground is recommended instead.

Please note that separate flash head mounting is not intended as a field option. The method of flash head mounting should be specified when the equipment is ordered. Details pertaining to separate mounting are usually supplied by others.

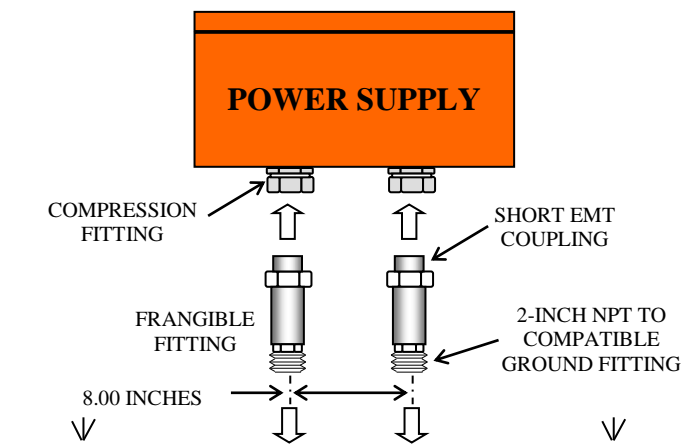
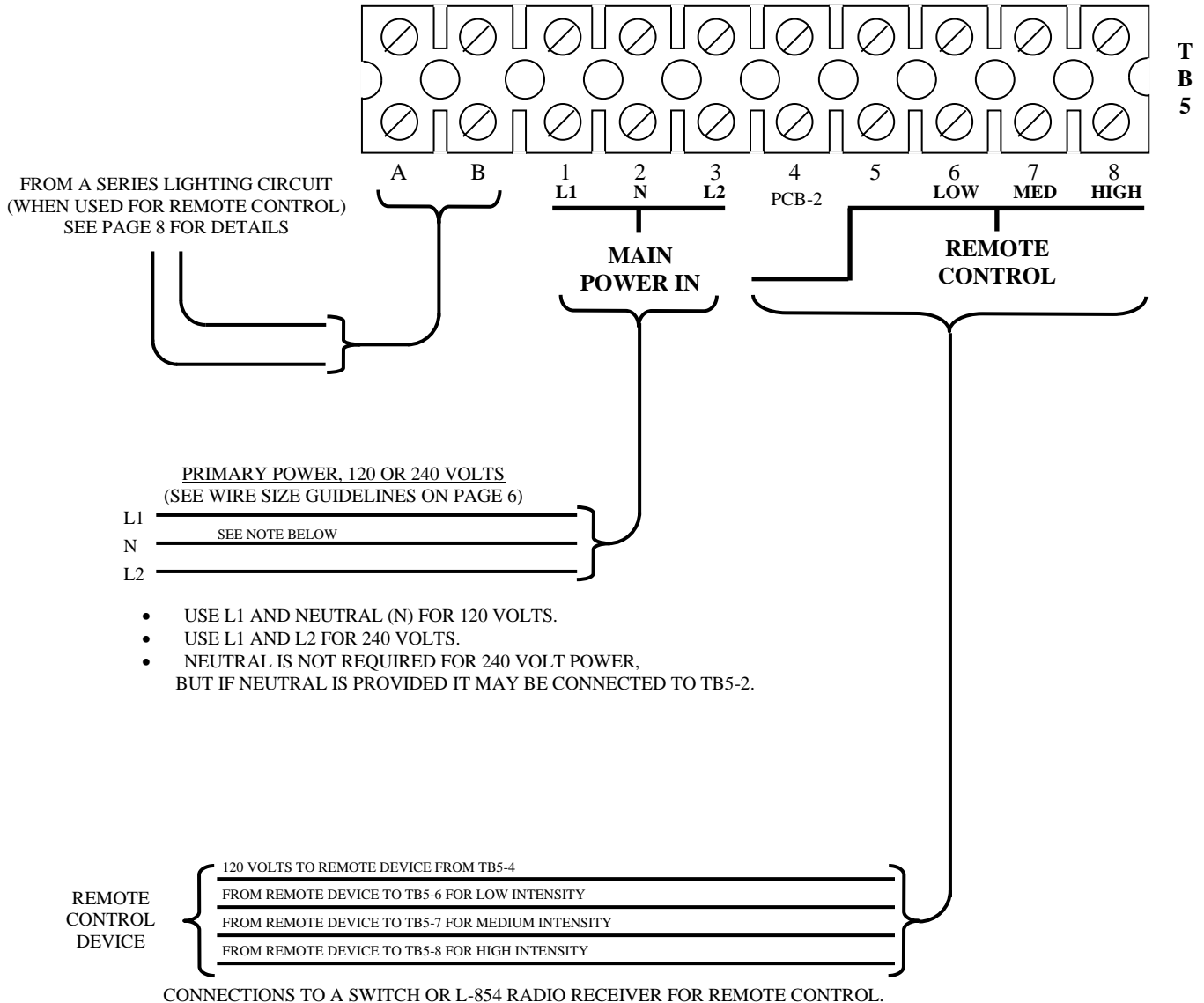

**Figure 2, Typical Mounting Details**

## INSTALLATION (Cont.)

### PRIMARY POWER HOOKUP:

Power is brought into the system through the master unit where it is connected to terminal TB5 as indicated in Figure 3. A neutral wire is required only for units that use 120 Volt primary power. It is not required for 240 Volt units, but if 240 Volt power is supplied in a 3-wire format, the neutral wire may be connected to position 2 on TB5. It is not necessary to carry the neutral wire to any of the 240 Volt slave units.



**Figure 3**  
**Installation Wiring Guidelines For a Master Unit**

### PRIMARY POWER HOOKUP (Cont.)

A slave unit does not have a TB5 terminal block, but all units, whether master or slave, have a TB1 terminal block. Primary power is distributed from TB1 in the master unit to TB1 in a slave. Labeling for TB1 in a 240 Volt unit is different than the labeling in a 120 Volt unit as shown in Figure 4. The terminals labeled “To next unit” are used in the master, and the terminals labeled “From previous unit” are used in the slave. Additional slave units can be connected in a similar manner (See Figure 6).

Terminals 1 and 3 are used for 240 Volts; Terminal 2 is unused.

Terminals 1 and 2 are used for 120 Volts, and Terminal 3 is unused.

Units for 230 Volts, 50 Hz, are wired as shown for 240 Volts.

Units for 60 Hz are not interchangeable with units for 50 Hz.

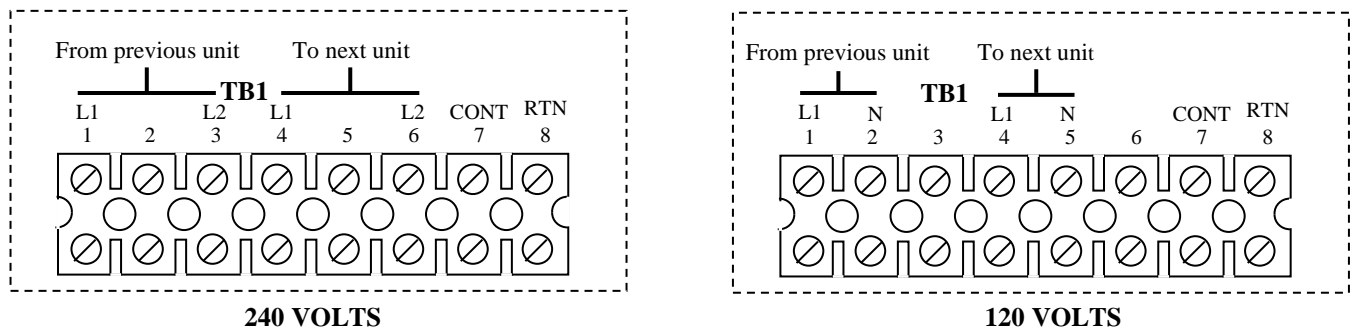

**Figure 4**  
**TB1 Labeling**

### Wire Size Guidelines For Primary Power:

Wire size (gage) depends on the primary voltage, the length of the run, the total electrical load, and the permissible voltage drop due to resistive loss. To determine wire size for a REIL system (two lights) use a load of 300 watts (total for two lights) and a voltage drop due to wire loss of not more than 10%. For systems with sequential flashers use a load of 150 watts for each light, bearing in mind that the power conductors to the master unit carry the current that feeds the entire system when it is wired up as shown in Figure 6. Routing system power through the master unit for a system containing more than 7 lights is not recommended. It is expected that NEC and local electrical codes will also apply.

## CONTROL LINE HOOKUP (Figures 5 & 6)

A two-conductor control line must be run between the power supplies. These conductors must be twisted together to minimize effects from electrical fields in close proximity, and especially from power conductors. The ideal control line consists of two stranded AWG 12 conductors twisted together with 3 to 4 twists per foot. A shielded cable is neither required nor recommended. AWG 12 wire is cited only for its mechanical strength; it is not an electrical requirement because the control signal current is very low.

Control line connections are made at TB1, Terminals 7 and 8, in each power supply. Terminal 7 carries the driving signal, and Terminal 8 the return. Terminal 8 is also tied internally to the equipment chassis.

Be sure the wires are inserted into the terminal block cavities between the two clamping plates. The clamping screws must be firmly tightened to assure long-term reliability. Always tug on the wires to test them for secure holding after the terminal block screws have been tightened. This is especially important when more than one wire is inserted under a clamp.



Master Unit



Slave Unit

**Figure 5**  
**Control Line Connections**

Figure 5 depicts control line connections in a master unit and a slave. When there are multiple slave units as in an ODALS the control line must be “daisy chained” from one slave unit to the next as inferred in Figure 3. Since the daisy chain connections are made at Terminals 3 and 4 there will be two conductors at those positions in all but the first unit (the master) and the last slave unit in the chain.

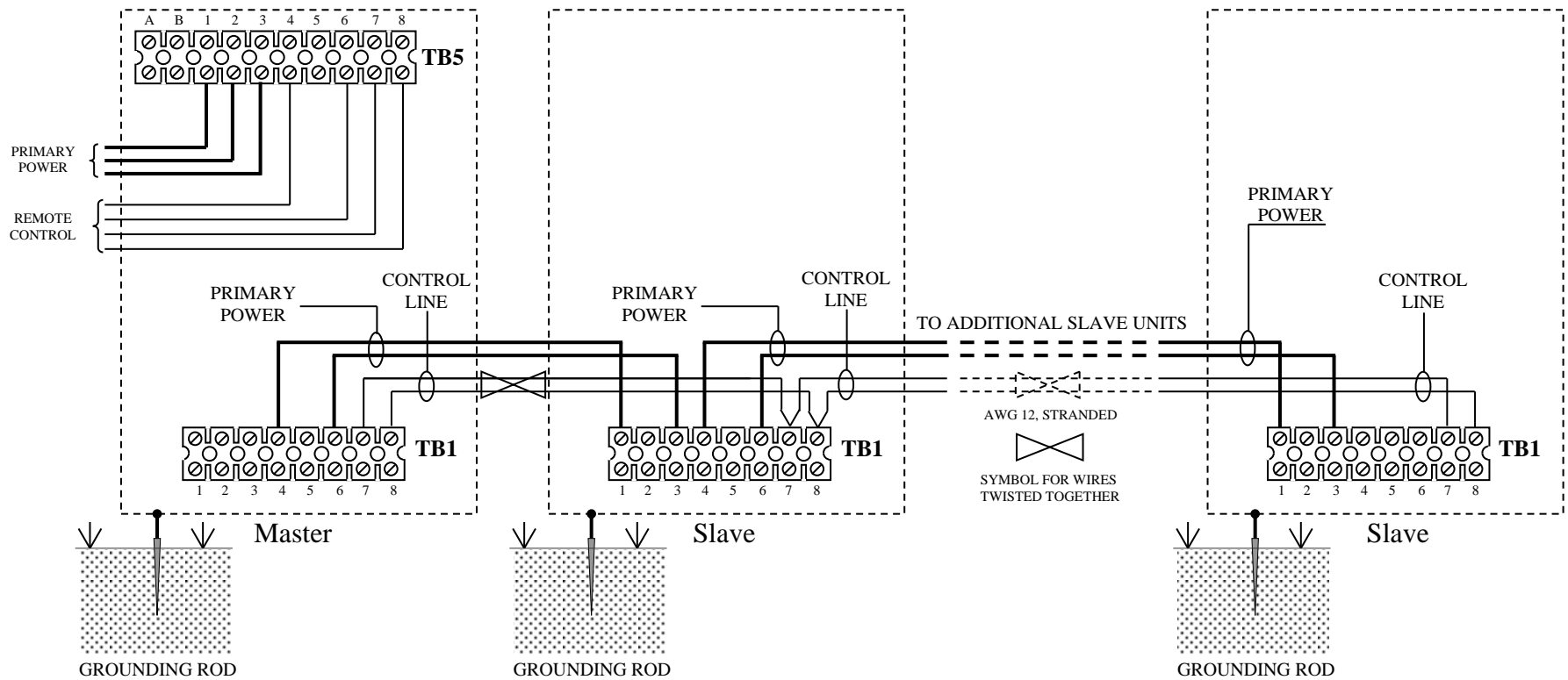

**Figure 6**  
**Basic System Interconnection Wiring**

The control line conductors must be twisted together. Three or four twists per foot are recommended. Shielding is not necessary or recommended. AWG 12 is recommended for mechanical considerations only. It is not an electrical requirement.

Each power supply should be grounded locally for protection against lightning damage. An external grounding lug on the bottom of the power supply enclosure is provided for this purpose. A grounding rod should be installed at each power supply for the best protection.

**GROUNDING THESE POWER SUPPLIES TO A COUNTERPOISE COULD INCREASE THE RISK OF DAMAGE DUE TO LIGHTNING**

**REMOTE CONTROL HOOKUP:**

Connections to a remote switch or an L-854 radio receiver are made at TB5 in the master unit as shown in Figures 3, 6, & 7. The control voltage from the master unit is 120 Volts ac. It is internally generated and not electrically referenced to primary power except in systems that utilize 120 Volts as primary power. The current is less than .05 amperes rms. Wire size can be based on mechanical considerations alone because the electrical load is so low.

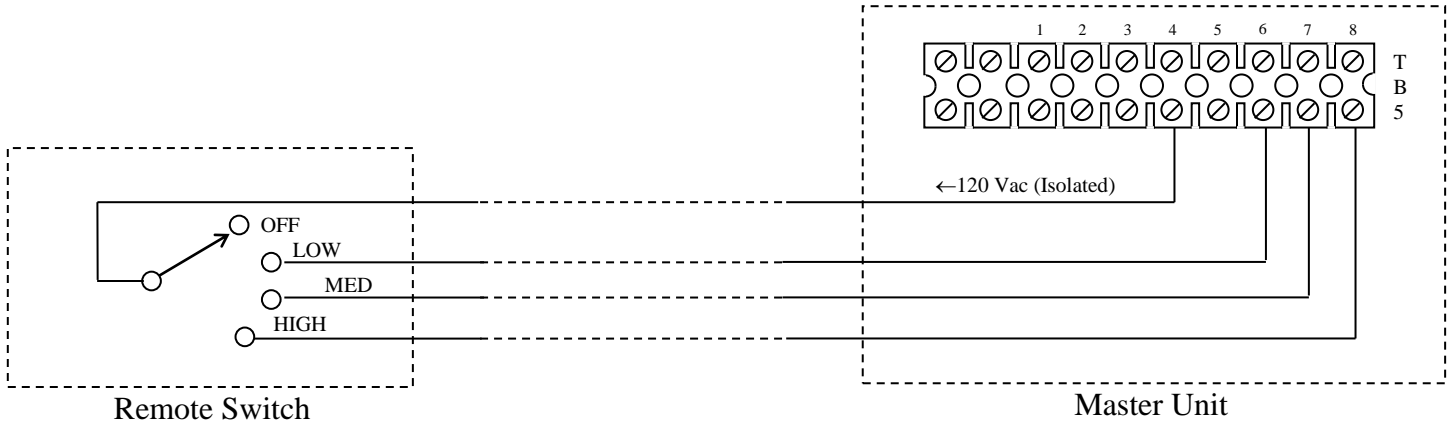

**Figure 7**  
**Remote Control Switch Circuit**

A Series Lighting Circuit (SLC) can also be used for remote control. This requires an optional module in the master unit that should be specified when the equipment is ordered. The wiring connections are shown in Figure 8. The L-823 cord set shown from terminals A & B is part of the optional equipment, but the L-830-1 Isolation Transformer is usually provided by others. This option may require initial setup adjustments in order to attain flash intensities at specific levels of SLC current. Refer to the setup procedures on Pages 13 through 16.

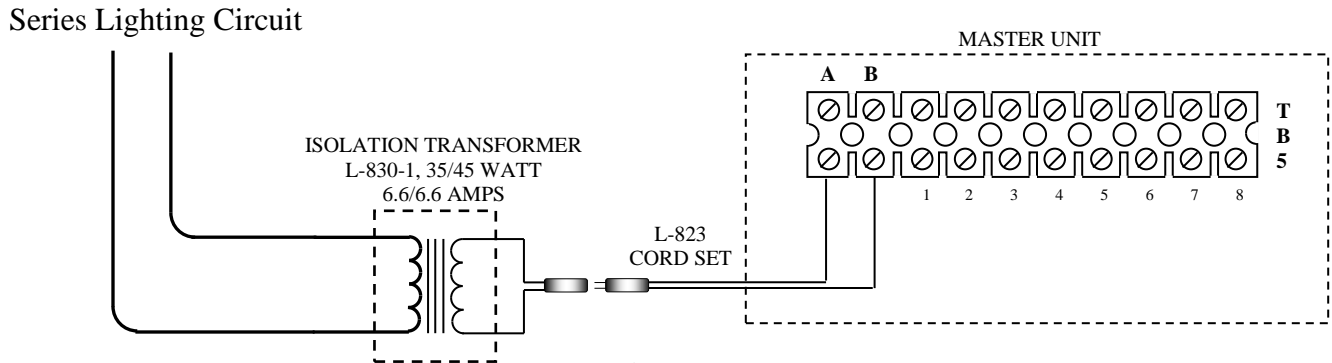

**Figure 8**  
**Remote Control By A Series Lighting Circuit**

## FUNCTIONAL DESCRIPTION

Each power supply, whether it is a master unit or a slave, has an identical PCB-1 circuit board for timing and control functions. These circuit boards communicate with one another over an interconnecting control line. System power is controlled by a circuit breaker that is part of a control module located in the master unit. Flash intensity may be controlled locally by a selector switch on the control module, or by a remote selector switch or L-854 radio receiver. The control module is also available with an option that enables the system to be controlled by a Series Lighting Circuit.

## APPLICATIONS

An ODALS by definition consists of seven omni-directional strobes flashing in a prescribed sequence. There are five lights situated on a line defining the approach to a runway's centerline and two lights (REILs) at the runway threshold. The lights flash sequentially towards the runway. The threshold lights flash last and they must flash simultaneously. Switch SW1 on PCB-1 controls flash sequence timing; SW2 controls the rate at which the flashes repeat. These switches are initially set at the factory to comply with the application as ordered, although changes can easily be made in the field.

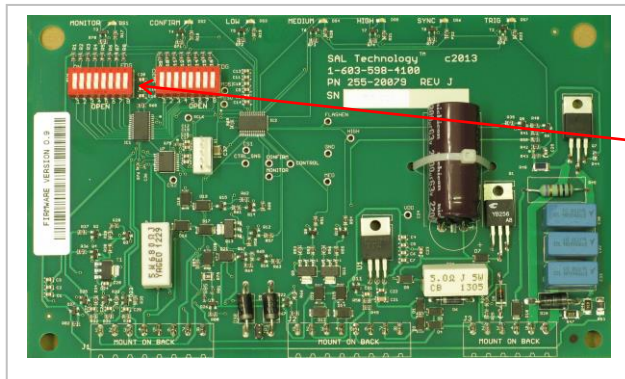

**Figure 9a**  
**PCB-1**

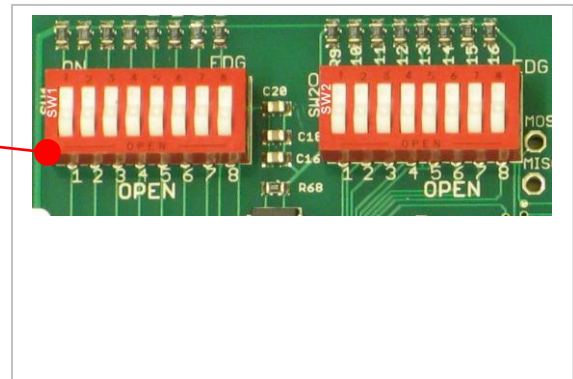
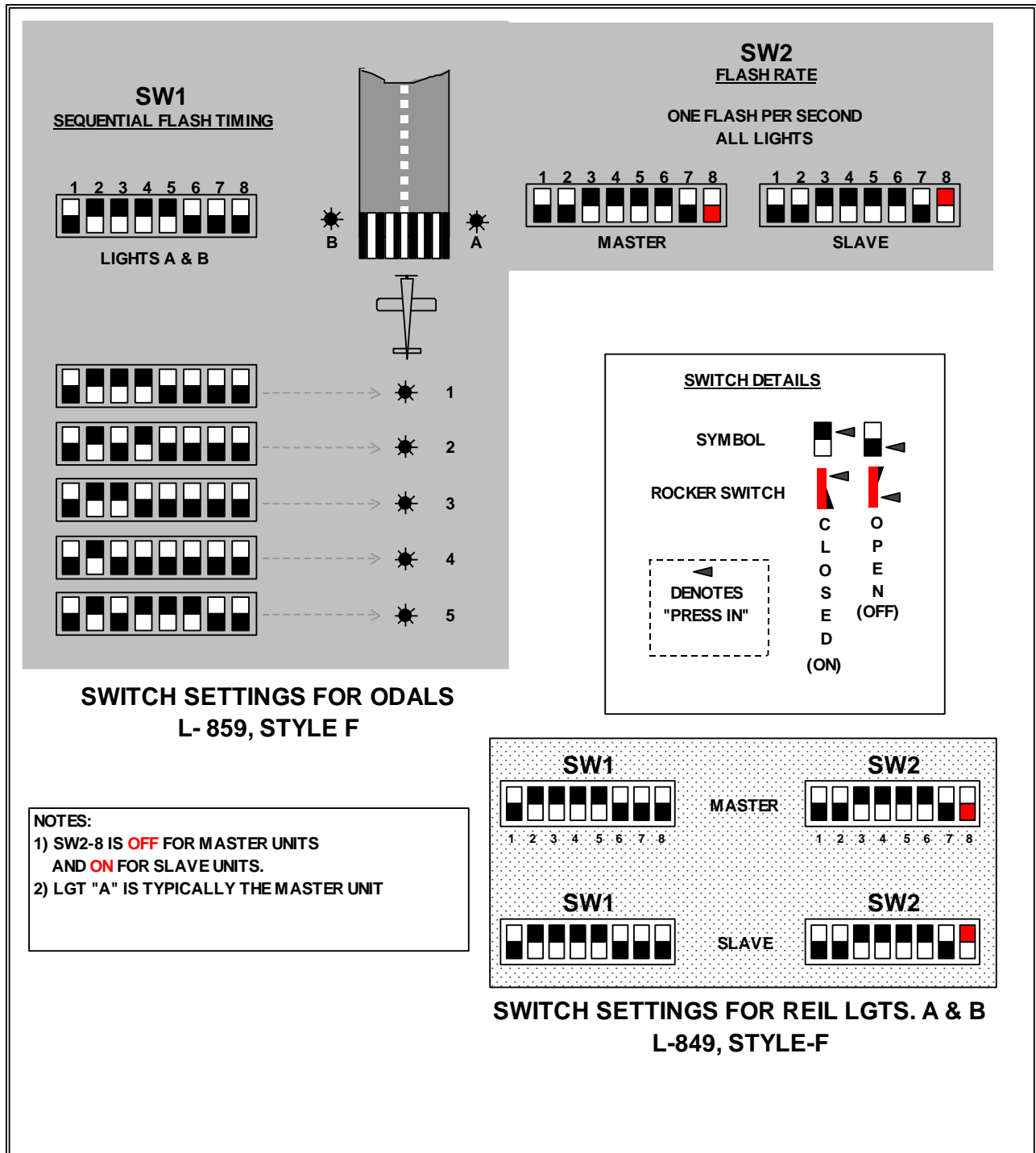

**Figure 9b**  
**Switch Detail**

Figure 10 shows SW1 and SW2 programming requirements for an ODALS (FAA Type L-859, Style F). Lights #1 through #5 must flash sequentially with #5 flashing first. The threshold lights, identified as A & B, must flash simultaneously after light #1 has flashed. The sequence repeats at one-second intervals. Since lights A & B must flash simultaneously they must be programmed identically. *Note particularly that SW2-8 is programmed differently in a master unit than it is in a slave.*

A Type L-849, Style F system consists of lights A & B only.





**Figure 10**  
**Circuit Board Programming**

## OPERATION

The Circuit Breaker (CB101) in the master unit must be closed in order to activate the system. When the circuit breaker is closed, the system can be controlled locally by means of SW101 on the CMV 111 Controller, or remotely when SW101 is in the REM (Remote) position. An auxiliary switch must be provided for remote operation. It typically would have four settings: Off, Low, Medium, & High, or it could be an L-856 Radio Receiver.



**Figure 11a**  
**CMV-111 Control Module**

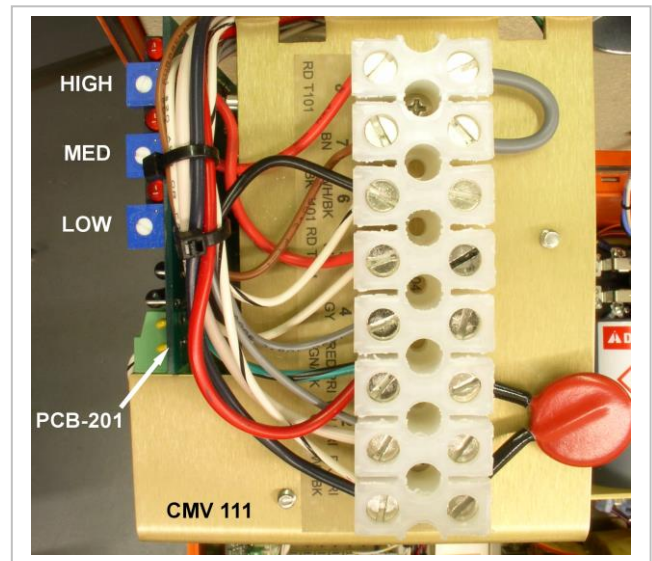

**Figure 11b**  
**Current Sensing Module**

A Series Lighting Circuit can also be used for remote control if that option has been elected at the time of purchase. A setup procedure is then required at installation. Instructions that cover most variations are on Pages 13 through 16. The adjusting potentiometers are on PCB-201. This circuit board is added to the CMV 111 Controller as a sub-assembly when the series control option is ordered. The adjusting potentiometers on PCB-201 are shown in Figure 11b.

## SET UP PROCEDURES FOR REMOTE SLC FLASH CONTROL

The equipment is set up at the factory according to sales order instructions when the system is ordered with the option of intensity control from a Series Lighting Circuit. A five-step regulator is used at the factory for these initial adjustments, and the system is set up for three levels of intensity unless it has been ordered for a single intensity application. The tables below show the typical factory settings for three-step and five step CCRs. Bear in mind that the flash mode response does not necessarily have to be the same as those shown in the tables. You can customize the response at your site by making new adjustments. You can select any three CCR steps for three levels of intensity, but the current for a higher intensity must always be greater than the current for a lower intensity. For example, you cannot set Low intensity to occur at CCR Step 2 if Medium intensity has been set for CCR Step 1.

CCR STEP	CURRENT (AMPS)	FLASH MODE
3	6.6	HIGH
2	5.5	MED
1	4.8	LOW

**Table 1**  
**Three-Step CCR**

CCR STEP	CURRENT (AMPS)	FLASH MODE
5	6.6	HIGH
4	5.2	MED
3	4.1	MED
2	3.4	LOW
1	2.8	LOW

**Table 2**  
**Five-Step CCR**

Although the switching levels are initially set up at the factory it is likely that they will have to be fine-tuned upon installation due to specific conditions at your site such as the type of CCR in use and other loads that may be driven by the same CCR. Adjustments are made at the current sensing module shown in Figure 11b. This module is part of the CMV-111 Controller when Series Circuit Control has been purchased as an option

Set Up Procedure for Three Levels of Intensity With a **Three-Step CCR** (Style 1)

**THE FOLLOWING INSTRUCTIONS REQUIRE SERVICING THE EQUIPMENT WHILE POWER IS APPLIED. USE APPROPRIATE CAUTION WHILE ACCESSING INTERIOR COMPONENTS.**

1. Open the cover of the master unit, and set the interlock switch to the ‘service’ position (pull up on the stem of the switch).
2. Flip the Circuit Breaker to the ON position (up).
3. Turn the Control Switch to REMOTE.
4. At PCB-201, (See Figure 11b) adjust all three potentiometers, LOW; MED; & HIGH, fully counter clockwise (CCW).
5. Set the CCR to Step 1 (4.8 amps).
  - Carefully adjust the LOW potentiometer CW until its adjacent LED comes on. Flashing will begin at Low intensity.
6. Set the CCR to Step 2 (5.5 amps).
  - Carefully adjust the MED potentiometer CW until its adjacent LED comes on. The unit will now flash at Medium intensity.
7. Set the CCR to Step 3 (6.6 amps).
  - Carefully adjust the HIGH potentiometer CW until its adjacent LED comes on. The unit will now flash at High intensity.
8. Set the CCR back to Step 2.
  - The HIGH LED should turn off. If it does not, adjust the HIGH potentiometer incrementally CCW until it does. The unit will then flash at Med intensity.
9. Set the CCR to Step 1.
  - The MED LED should turn off. If it does not, adjust the MED potentiometer incrementally CCW until it does. The unit will then flash at Low intensity.
10. It is advisable to run through the CCR steps once more to verify that switching is correct. Make any necessary adjustments to the potentiometers to achieve correct switching by repeating the steps above.
11. Leave the Control Switch in the REMOTE position for continuous control by the CCR.
12. No adjustments are required at a slave unit.

## Set Up Procedure for Three Levels of Intensity With a **Five-Step CCR** (Style 2)

### **THE FOLLOWING INSTRUCTIONS REQUIRE SERVICING THE EQUIPMENT WHILE POWER IS APPLIED. USE APPROPRIATE CAUTION WHILE ACCESSING INTERIOR COMPONENTS.**

1. Open the cover to the master unit, and set the Interlock Switch to the 'service' position (pull up on the stem of the switch).
2. Flip the Circuit Breaker to the ON position (up).
3. Turn the Control Switch to REMOTE.
4. At PCB-201, (See Figure 11b) adjust all three potentiometers, LOW; MED; & HIGH, fully counter clockwise (CCW).
5. Set the CCR to Step 1 (2.8 amps).
  - Carefully adjust the LOW potentiometer CW until its adjacent LED comes on. Flashing will begin at Low intensity.
6. Set the CCR to Step 2 (3.4 amps).
  - The LOW LED should remain on and flash intensity should be unaffected.
7. Set the CCR to Step 3 (4.1 amps).
  - Carefully adjust the MED potentiometer CW until its adjacent LED comes on. The unit will switch to Medium intensity flashes.
8. Set the CCR to Step 4 (5.2 amps).
  - The MED LED should remain on and flash intensity should be unaffected.
9. Set the CCR to Step 5 (6.6 amps).
  - Carefully adjust the HIGH potentiometer CW until its adjacent LED comes on. The unit will switch to High intensity flashes.
10. Set the CCR back to Step 4.
  - The HIGH LED should turn off. If it does not, adjust the HIGH potentiometer incrementally CCW until the LED turns off. MED & LOW LEDs should remain on.
11. Set the CCR to Step 3.
  - There should be no change from the conditions in Step 10.
12. Set the CCR to Step 2.
  - The MED LED should turn off. If it does not, adjust the MED potentiometer incrementally CCW until the MED LED turns off. The LOW LED should remain on and the unit should be flashing at Low intensity.
13. Set the CCR to Step 1.
  - There should be no change from the conditions in Step 12.
14. It is advisable to run through the CCR steps once more to verify that switching is correct. Make any necessary adjustments to the potentiometers to achieve correct switching by repeating the steps above.
15. Leave the Control Switch in the REMOTE position for continuous control by the CCR.
16. No adjustments are required at a slave unit.

## Set Up Procedure for **Single** Intensity Operation

**THE FOLLOWING INSTRUCTIONS REQUIRE SERVICING THE EQUIPMENT WHILE POWER IS APPLIED. USE APPROPRIATE CAUTION WHILE ACCESSING INTERIOR COMPONENTS.**

The procedure for single intensity operation is essentially the same for all CCRs whether they are three or five-step regulators (Style 1 or Style 2).

Most single intensity runway approach strobes operate at High intensity, although the system could also be set up for a single intensity of Medium or Low.

For single **High** intensity operation:

1. Open the cover to the master unit, and set the Interlock Switch to the 'service' position (pull up on the stem of the switch).
2. Flip the Circuit Breaker to the ON position (up)
3. Turn the Control Switch to REMOTE.
4. At PCB 201 (See Figure 11b), adjust all three potentiometers, LOW; MED; & HIGH, fully counter clockwise (CCW).
5. Set the CCR to the current level at which you want the light to start flashing (must be at least 5.2 amperes).
6. Adjust the HIGH potentiometer CW until the adjacent LED comes on. The strobe will begin flashing at High intensity.
7. Do not adjust the MED or LOW potentiometers. They must remain fully CCW.
8. Set the CCR (whether 3-step or 5-step) to the next lower step. The HIGH LED should extinguish, and the strobe should stop flashing. If it does not, adjust the HIGH potentiometer incrementally CCW until it does.
9. Test the adjustments by observing the results as the CCR is switched from one step to another.
10. Leave the Control Switch in the REMOTE position for continuous control by the CCR.
11. No adjustments are required at a slave unit.

Contact the factory for other custom flash control conditions.

## **THEORY OF OPERATION**

A xenon capacitive discharge light is often referred to as a “strobe”. A flash is produced when sufficient electrical energy is abruptly ‘dumped’ into a lamp filled with xenon gas. The gas, which is normally nonconductive, must be brought to a conductive state for a flash to occur. This requires applying a pulse of high amplitude (a triggering pulse) to the lamp. The energy producing the flash is stored in a bank of capacitors connected to the lamp electrodes. The capacitors, charged to a relatively high potential, discharge through the lamp when the internal gas becomes conductive.

SAL Technology strobes consist of two major subassemblies called power supplies and flash heads. A power supply converts external ac primary power to dc (direct current) that is fed to a bank of energy storage capacitors bringing them to a charge potential of about 1000 Volts dc ( $\pm 500$  Volts).

Most runway approach strobes must be capable of 3 levels of flash intensity—High, Medium, and Low. Flash intensity levels are changed by switching the lamp to different values of bank capacitance.

Flash head components consist of a sealed-beam xenon lamp, a triggering transformer, and additional minor circuitry. The flash head is connected to the power supply by a short harness if it is co-mounted or by a cable when it is installed remotely. The harness/cable connects the bank of capacitors in the power supply to the anode and cathode flash lamp electrodes. The maximum voltage on the anode conductor is +500 Volts dc. The maximum voltage on the cathode conductor is –500 Volts dc. The total lamp voltage at discharge is therefore 1000 volts. The harness/cable also carries a low level triggering pulse that is applied to a small transformer in the flash head where it is boosted to a voltage level high enough to trigger the flash lamp into its conductive state. A coupling transformer located in the power supply provides an intermediate signal boost that improves triggering when a very long flash head cable is used.

A REIL system has two lights that flash simultaneously. Some approach lighting systems have as many as 21 lights that flash sequentially. The practical limit for SAL Technology sequential flashers is even higher. The point is that these lights must always operate as an integrated system. This requires a form of communication between the lights. The method used in SAL Technology systems is an encoded signal that is distributed by an interconnecting control line. The encoded signal carries timing and flash intensity information that originates at a master unit. The only difference between a master unit and a slave unit is an internal control module residing in the master unit. The control module monitors the current in a Series Lighting Circuit and provides adjustments for setting intensity switching thresholds at specific levels of SLC current.

## MAINTENANCE

SAL Technology approach lights require only minimal maintenance.

### Every 6 months

- Make sure that the cover latches are secured and holding the cover tightly closed.
- Check the venting plug on the bottom of the power supply, and clear the breathing holes if they have become clogged.
- Check co-mounted flash head sealing. There should be a continuous bead of sealing compound between the housing hub and the EMT compression nut as shown in Figure 12. Use Gardner-Bender DS 110, or similar, Duct Seal when repairing or replacing.
- Check screw tightness on TB1 and TB3 (8-position terminal blocks; (See Figure 13 for locations). Check every position that has a wire connection whether to external wiring or to internal circuits. You should also check TB5 in master units.

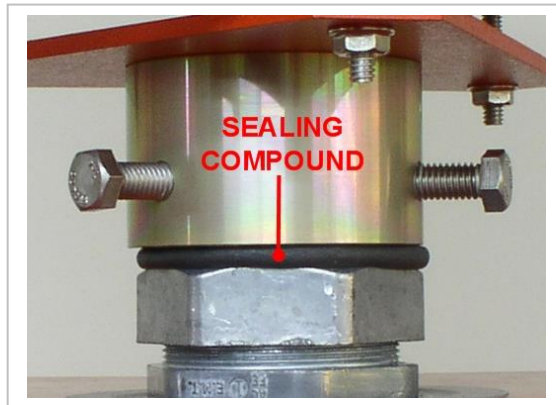

**Figure 12**  
**Co-mount Hub Sealing**

### Annually:

- Check the neoprene cover gasket on the power supply enclosure for nicks or tears. If repair is needed use a neoprene compatible adhesive. RTV may not adhere well to the neoprene gasket.
- Perform a mode switching response check. Verify the lights respond correctly to all commands from the SW101 Control Switch in the master unit.
- Verify that the flash rate is correct (60 flashes per minute).
- Verify that the threshold lights flash simultaneously, and that sequenced lights flash in the correct order.



## TROUBLESHOOTING

Some problems affect only one light while other problems may affect part or all of an entire system. Most problems occur at initial turn on. This is primarily because the control line is the only untested part of a newly installed system. Control line problems usually affect not just one, but all, of the lights in a system. It is, however, possible for only one light to be affected if a programming switch was bumped while working in a power supply during electrical hookup causing it to become unintentionally reprogrammed.

Faults that may arise after a system has been working properly are usually due to rather predictable causes brought on by component aging, deferred maintenance, or perhaps some type of damage. These problems usually affect only one light, although there can be exceptions.

It is important to know where the major components are located, especially when attempting to follow troubleshooting procedures. Use Figures 13 and 14 for this information. A slave power supply does not have a CMV 111 Control Module; it is otherwise identical to a master power supply.

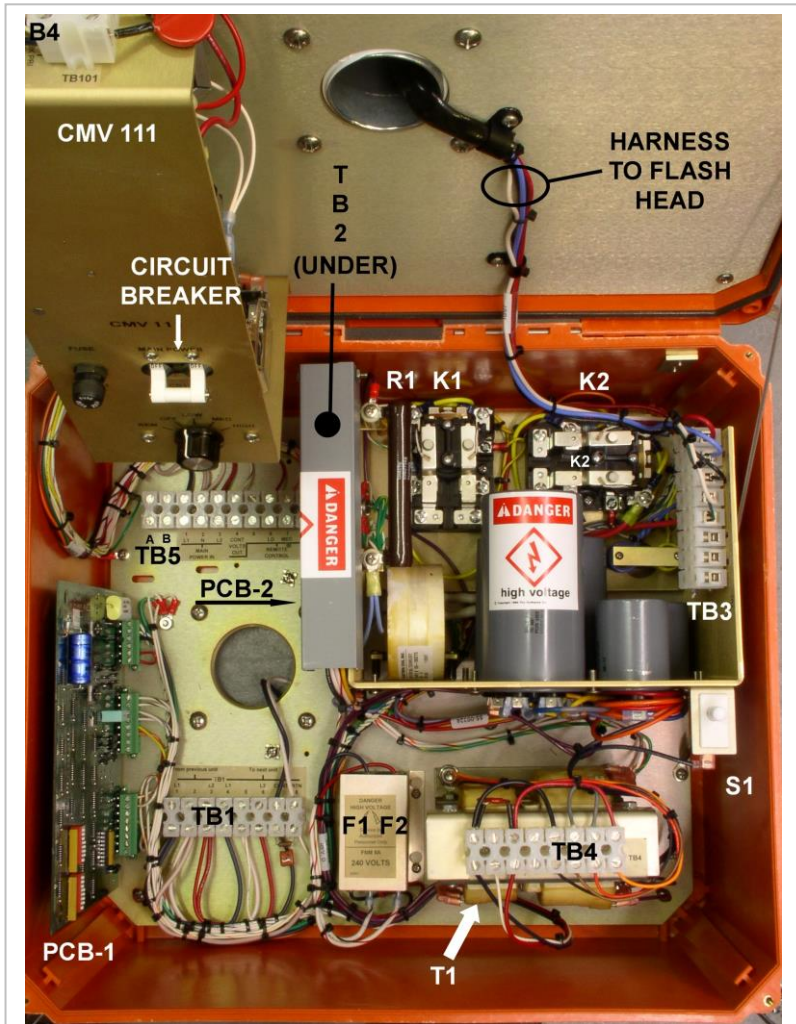

**Figure 13**  
**Master Power Supply Components**

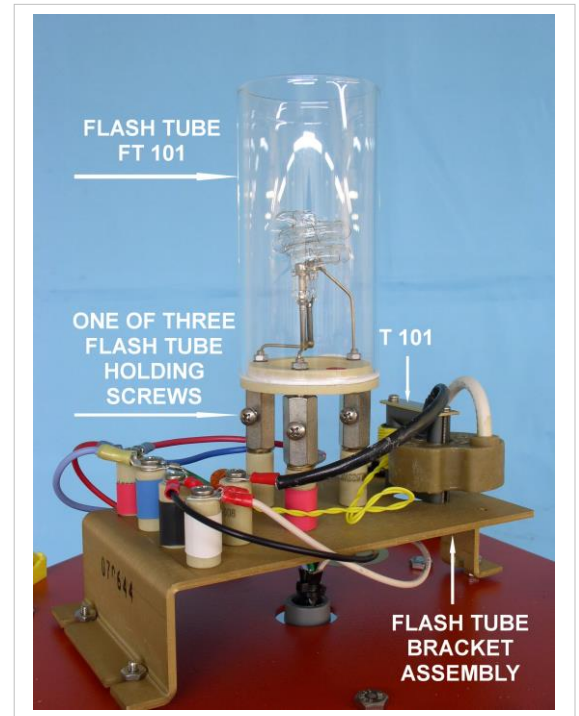

**Figure 14**  
**Flash Head Internal Components**

## TROUBLESHOOTING-STATUS LIGHTS

Each power supply has two circuit boards with indicator lights that can be used to interpret operating conditions. PCB-1, shown partially in Figure 15, is the timing and control circuit board. Its location is shown in Figure 13. It has six red LEDs, but only four of these apply to standard functions. DS1 and DS2, labeled Monitor and Confirm, are used only when the Monitoring option has been elected at the time of purchase. DS7 is a neon glow lamp. SW1 and SW2 are programming switches.

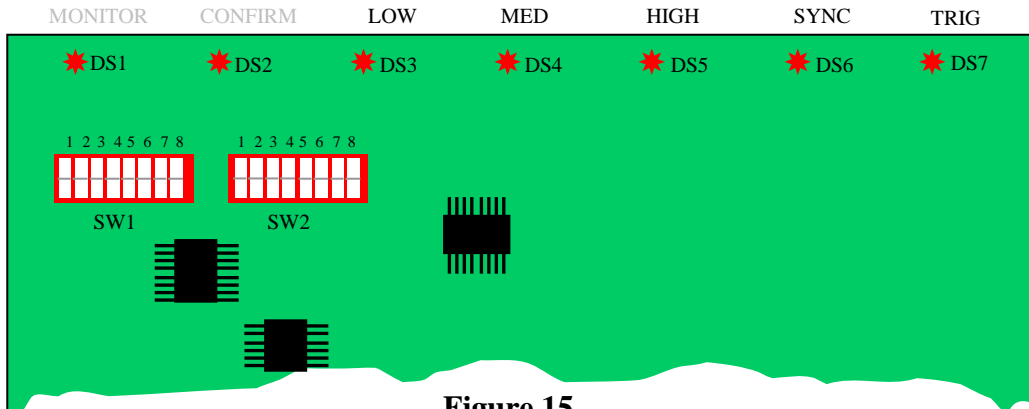

Figure 15  
PCB-1 Status Lights

PCB-2 does not show in Figure 13, but its location beneath the High Voltage Guard is noted (). The LEDs on PCB-2 are in prominent view for safety and troubleshooting. ***Do not touch any circuit component within the power supply or flash head when LED1 or LED2 is lit.***

LED1 and LED2 are high voltage indicators. The bank voltage consists of a negative component and a positive component—each reaching about 500 volts dc at full charge. Both lights must be lit for flashing to occur.

**The full bank voltage is 1000 Volts dc. This is a dangerous potential. Use appropriate caution.**

### **NOTE:**

There is no interlock switch the flash head.

***Always turn off the power supply when accessing the flash head.***

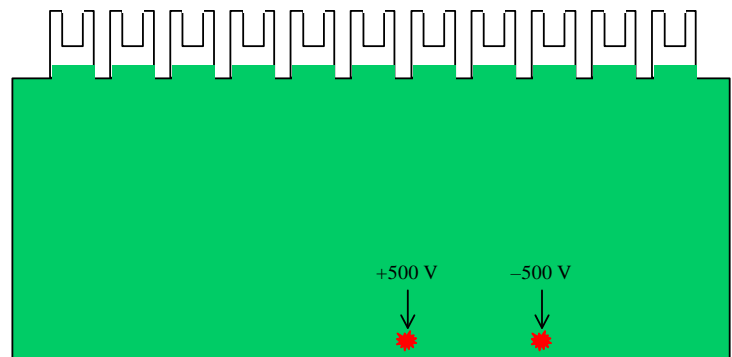

Figure 12  
PCB 2 Status & Safety Lights

## TROUBLESHOOTING–NORMAL INDICATIONS

Effective troubleshooting does not necessarily require measuring instruments. Most problems can be identified by audio and visual techniques, but first one must know what to look and listen for as the equipment operates. When a light is working properly there will be characteristic sounds and circuit board status light conditions. Recognizing the absence of any normal indication is the first step in tracking down the cause of a malfunction. To use sight and sound diagnostically you should know what to look and listen for in normal operation.

With power applied, the interlock switch set to the service position (plunger pulled upwards), a unit that works correctly will flash steadily at a rate of 120 FPM. The flash intensity will depend on the control switch setting in the master unit, or at a remote switch when in remote control.

### Diagnostics By Sight and Sound

When a light is operating correctly:

- There will be an audible “buzz” from the T1 power transformer.
- There will be an audible “thump” accompanying each High intensity flash as the capacitors discharge through the lamp. This discharge thump may not be noticeable for Medium or Low intensity flashes.
- There will be a sharp, audible snap coinciding with each Medium and Low intensity flash if the flash head is co-mounted. The snap is from the triggering circuit in the flash head. At High intensity the snap is likely to be completely masked by the louder discharge thump. The snap may not be noticeable if the flash head is remotely mounted from the power supply.
- DS7 will ‘wink’ out with each flash.
- DS6 will blink at the same rate as flashing, but does not quite coincide with the flashes.
- In High mode, DS5, DS4, & DS3 will be on steady.
- In Medium mode, DS 5 & DS4 will be on steady, and DS3 will be off.
- In Low mode DS5 on will be on steady\*; DS3 & DS4 will be off.

An exception to any of the above conditions is the first troubleshooting clue. Procedures for identifying the cause of a problem are broken down into categories to speed up troubleshooting. The broadest category is whether the problem is occurring at initial turn-on of the system or after the system has previously worked correctly. The next category is whether the problem affects one light only or appears to be a system problem affecting all or most of the lights. Possible causes are generally listed according to estimated probability.

## I. PROBLEMS OCCURRING AT INSTALLATION

The most common problems when a system is first turned on are:

1. Flashing at the wrong intensity or Erratic Flashing.
2. No Flash at all.

**Erratic Flashing** is the term used when a light skips flashes or toggles from one intensity to another as it flashes.

Erratic flashing that affects an entire system could be caused by sporadic intensity changes that could appear as missed flashes when viewed from a distance.

These problems would typically affect all of the lights the same way, but there can be exceptions.

A. When all of the lights are affected:

### 1. Flashing at the Wrong Intensity or Erratic Flashing

Probable cause—Electrical interference on the control line.

Disconnect the control line at TB1, Terminal 7 in the master unit. If the master unit then works properly reconnect the control line, and remove the control line from TB1, Terminal 7 in the slave unit. If the slave unit then works properly, the problem is being caused by interfering signals on the control line. See control line comments below.

### 2. No flash at all

Probable cause—**Severe** interference on the control line could prevent flashing altogether.

Control line requirements:

The control line wires must be twisted together. Shielding is not necessary or recommended. Shielding is not a substitute for twisting. If the control line consists of two wires twisted together inside of a surrounding shield, it might help to disconnect the shield at both ends. A control line problem can usually be further verified by temporarily laying a substitute line (twisted) on the surface between the master and slave units.

B. When only one light is affected

### No flash or flashing at the wrong time

- This is an unusual condition at initial turn on. If it does happen it is most likely because a programming switch on PCB-1 was unintentionally bumped and reprogrammed while working inside the power supply during installation. Correct programming information can be found in Figure 6 and also on the inside of the power supply cover for the unit affected.
- It is also possible that the equipment was somehow damaged after leaving the factory.
- If the flash head is located remotely from the power supply, the cable could be incorrectly hooked up.

## II. EVOLVING PROBLEMS (When a Light Stops Working Correctly)

Most problems that occur after a system has been working correctly affect only one light. These typically fall into one of the following categories:

### A. No Flash

### B. Wrong Intensity

### C. Skipping Flashes

The method of fault isolation prescribed below consists mainly of following the tips leading to a specific component, and verification by temporarily exchanging that component with one known to be working correctly.

### A. No Flash

1. Blown Fuse in the power supply?
2. No High Voltage, evidenced by DS1, DS2, & DS3 on PCB-2 not being lit:
  - a) PCB-2 defective.
  - b) T1 Power Transformer defective.
  - c) Bank capacitor shorted. Call 1-603-598-4100 for assistance.
3. No Trigger, evidenced by no audible 'snap' in Low or Medium mode:
  - a) Change PCB-1 if DS7 is on steady.
  - b) Change PCB-2 if DS7 on PCB-1 is not lit—then change PCB-1 if DS7 remains unlit.
  - c) Change T101 (trigger transformer in flash head) if the problem is yet unresolved.
4. Defective flash Lamp:  
Change out the flash lamp

## EVOLVING PROBLEMS, Cont.

### B. Wrong Intensity

1. DS5, DS4, or DS3 do not agree with the LED mode indications at the CSM-112 Controller:
  - a) Change out PCB-1.
  - b) Change out PCB-101.
2. DS5, DS4, & DS3 agree with the CSM-112, yet the flash intensity is wrong:
  - a) Check K1 & K2 for correct switching responses as shown in Table 3 below.

**Table 3, Mode Relay Conditions**

RELAY	IN*	OUT	INTENSITY
K1		√	LOW
K2		√	
K1		√	MED
K2	√		
K1	√		HIGH
K2	√		

\* IN means the relay is 'pulled in', that is, energized.

### C. Skipping Flashes

When a flash lamp skips flashes it is probable that either the flash lamp or the trigger transformer is approaching failure. To pin down which one:

- a. Turn off the power. Power is automatically turned off when the power supply cover is opened. Do not pull up the stem of the interlock switch to the service position.
- b. Disconnect the RED wire from TB3 in the power supply (be sure DS3 on PCB-2 is not lit).
- c. Apply power (pull up on the interlock switch plunger).
- d. Listen for trigger snaps as mentioned earlier.
- e. Change out the T101 trigger transformer if trigger skipping is detected.
- f. Change out the flash lamp if the trigger does not skip.
- g. Replace the RED wire to TB3 and tighten the terminal block screw firmly.

## REPLACING FLASH HEAD COMPONENTS

The following instructions apply to replacing major flash head components. It is necessary to remove the lens to gain access to these components. Access instructions are on Page 2 of this manual.

**Be sure to read the instructions on Page 2 for re-installing the lens.**

### 1. FLASH TUBE (Figure 17a)

The flash tube is held by a pin and socket arrangement. The pins are anchored in the ceramic base of the flash tube. The sockets are part of the flash tube bracket assembly, and provide mechanical as well as electrical functions. Each socket has a Phillips head set-screw that engages the flash tube pin. These setscrews are shown in Figure 17b.

### CAUTION

**A replacement flash tube is shipped with foam packing wedges inserted between the tube helix and the outside cylinder. These wedges must be removed when the flash tube is installed.**

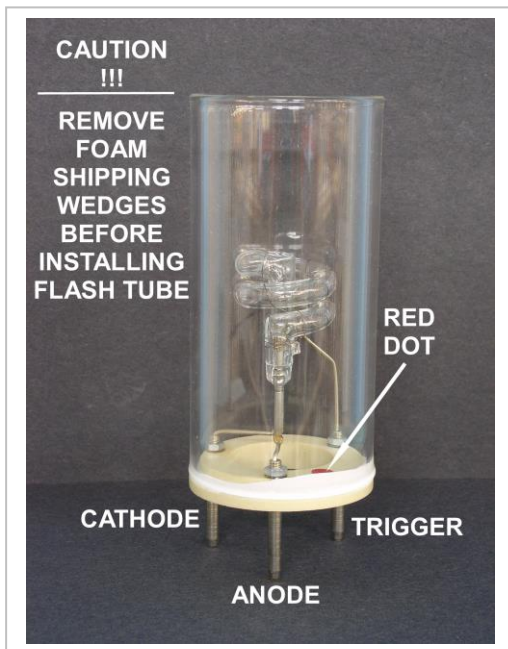

**Figure 17a  
Flash Tube**

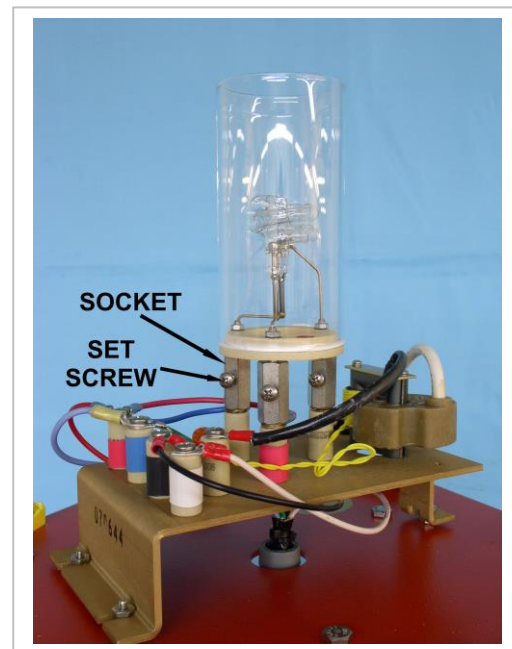

**Figure 17b  
Flash Tube Bracket**

#### Removal:

Loosen, but do not remove, the three setscrews holding the flash tube.

- Lift the flash tube straight up until the three electrode pins are free of their sockets.

#### b) Replacement:

One of the flash tube electrode pins (the anode) is identified by a red dot on the inside surface of the ceramic base. This pin must be inserted into the socket identified by a red band around the insulating post to which it is attached.

- Insert the flash tube into the sockets until it is firmly seated against the top surfaces of all three of the sockets.
- Tighten the three setscrews snugly.

## 2. TRIGGER TRANSFORMER HV COIL

The trigger transformer is an open frame device consisting of a primary coil, a potted high voltage (HV) coil, a ferrite core, and assembly hardware. The entire assembly is held to the flash tube bracket by two 4-40 Phillips head screws. It is generally unnecessary to replace the entire transformer assembly if a problem develops. A kit (PN 255-20027) is available for field repair.

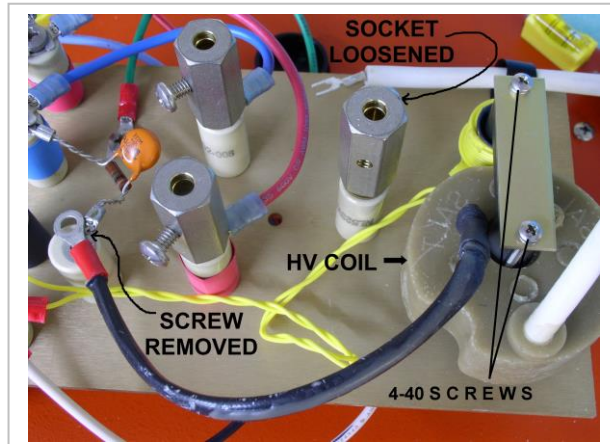

**Figure 18a**  
**HV Coil Removal**

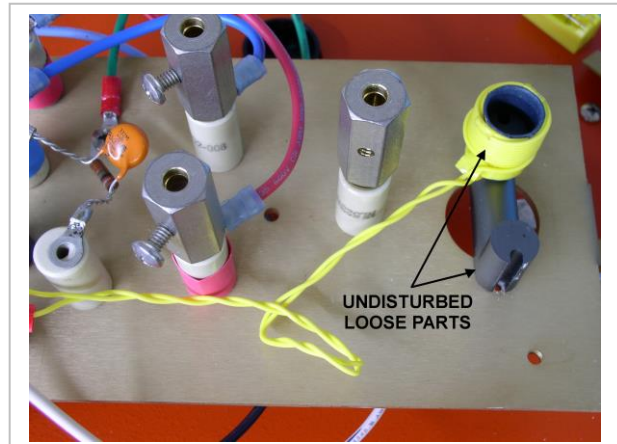

**Figure 18b**  
**T101 Partial Assembly**

### Removal:

- Loosen the setscrews identified in Figure 17b, and remove the flash tube.
- Loosen the hex socket identified in Figure 18a. It may be necessary to grip the ceramic post with pliers in order to loosen the socket.
- Detach the large white wire from the HV coil to the hex socket just loosened.
- Remove the terminal screw identified in Figure 18a that secures the black wire from the HV coil.
- Remove the “P” clamp screw that secures the white HV lead to the flash tube chassis.
- Remove the two 4-40 screws and the flat plate identified in Figure 18a.
- Carefully lift the top half of the ferrite core away.
- Lift the HV coil from the bottom half of the ferrite core and try to leave the rest of transformer parts in place as shown in Figure 18b.

### b) Replacement:

- Install the replacement HV coil over the bottom half of the ferrite core with the white HV lead positioned in the same manner as the original.
- Insert the upper half of the ferrite core down through the center of the HV coil and the spool that holds the primary coil.
- Re-install the small flat plate and the long 4-40 screws.
- Tighten the screws symmetrically—alternating from one to the other until they begin to tighten.

**Be very careful when-tightening these screws because over-tightening can fracture the ferrite core.**

- Re-attach the white wire to the hex socket identified in Figure 18a, and tighten the socket to the insulating post.
- Re-attach the black wire from the HV secondary coil to the ceramic insulating post also identified in Figure 18a.
- Re-install the flash tube and tighten the three setscrews that hold it.
- Re-install the lens (**See the instructions on Page 2**).



**Table 4, Major Replaceable Parts**

REF	DESCRIPTION	PN
A-100	Flash Head Bracket Ass'y (See Figure 17b)	255-20248
C1	Bank Capacitor, 40 $\mu$ f	55-00106
C2,C3	Bank Capacitor, 20 $\mu$ f	55-00107
C4	Bank Capacitor, 5 $\mu$ f	55-00110
C5	Bank Capacitor, 4.5 $\mu$ f	55-00111
C6	Tuning Capacitor, 3 $\mu$ f	55-00259
CB 101	Circuit Breaker, 20 Amp (For CMV-111.1 & 111.3)	55-00406
CB 101	Circuit Breaker, 20 Amp (For CMV-111.2)	55-00483
FT 101	Flash Tube	55-00360
F 101	Fuse, 1.5 Amps, Master unit only, (Remote Control)	55-00267
F1, F2	8 Amps, (F1 only for 120 volts, or 230 Volts, 50 Hz)	55-00186
K1, K2	Relay, Mode Switching	55-00193
PCB-1	Printed Circuit Board, Timing & Control	255-20079
PCB-2	Printed Circuit Board, High Voltage Rectifier, Type V	255-20081
PCB-201	Printed Circuit Board, Current Sensing Option (See Figure 11b)	255-20086
P1, P2	Ceramic Standoff, 1 inch, (for R1, See Figure 19)	55-00200
R1	Capacitor Bleed Resistor, 75 k $\Omega$ , 50 W	55-00228
S1	Interlock Switch	55-00201
T1	Power Transformer, High Voltage: 60 Hz; Specify 120 or 240 V.	55-00224
T1	Power Transformer, High Voltage: 230 Volts, 50 Hz	55-00386
T 101	Trigger Transformer Kit	255-20027
TB1, TB3	Terminal Block, 8 Position	55-00146
TB2	Terminal Block, 11 Position (for PCB-2)	55-00273
TB5	Terminal Block, 10 Position (Master unit only)	55-00147

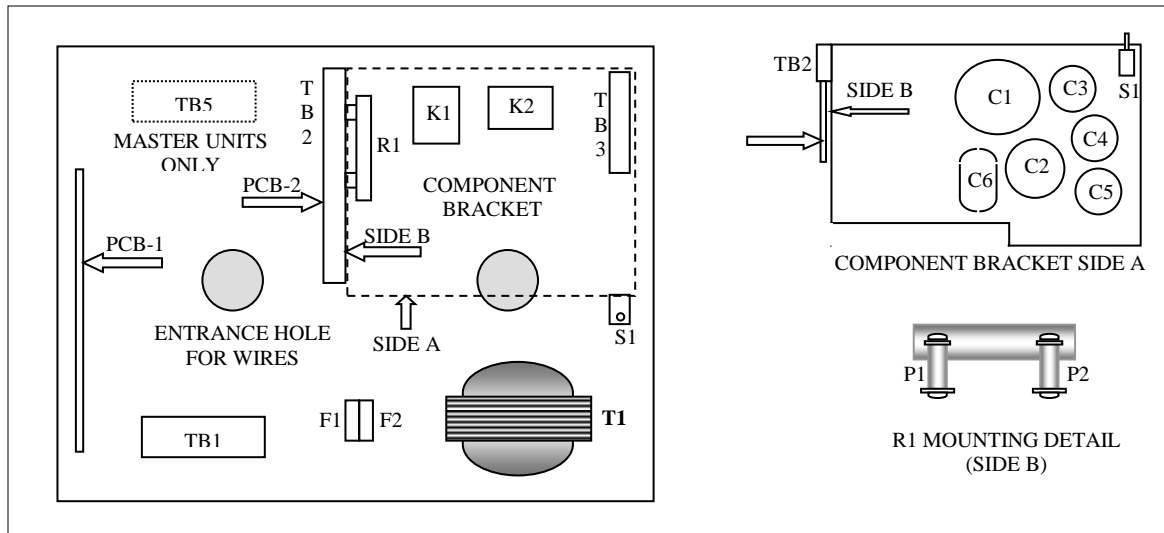

**Figure 19  
Component Location Diagrams**