

Airport**Lighting**Company
An ISO 9001:2015 Certified Company

OWNER'S MANUAL



US Patent 11,260,991

L-880(L) /L-881(L)
LED Precision Approach Path Indicator (PAPI)



LED PAPI L-880(L)/L-881(L) Owner's Manual

ETL Certified to:
FAA AC 150/5345-28 and EB 67

Compliant to:
ICAO: PAPI Annex 14, Volume 1 (Current Edition)
T/C: PAPI / APAPI Transport Canada TP 312 par. 5.3.16.12 and Appendix 5B, Figure B-19
CASA: PAPI Part 139
EASA: PAPI/APAPI EU No 139/2014



U.S. Patent 11,260,991

Manufactured by:
Airport Lighting Company
108 Fairgrounds Drive
Manlius, New York 13104
(315) 682-6460

Email: info@airportlightingcompany.com
Website: www.airportlightingcompany.com

L-880(L) /L-881(L) LED Precision Approach Path Indicator (PAPI)



U.S. Patent 11,260,991

Compliances (Current Editions)

FAA: AC 150/5345-28 and Engineering Brief No. 67, ETL Certified

ICAO: PAPI Annex 14, Volume 1

Canada: PAPI / APAPI Transport Canada TP 312 par. 5.3.16.12 and Appendix 5B, Figure B-19

CASA: PAPI Part 139

EASA: PAPI/APAPI EU No 139/2014



Application

This system enhances safety by providing visual approach slope guidance to assist the pilot of an aircraft in flying a stabilized approach.

Key Features

- Estimated Life of LEDs > 150,000 hours at full intensity
- LED Display indicates angle and status without opening
- Redundant Digitally Controlled Lens Heaters
- 89 Max VA per light unit with heater active
- Compact and Light Weight (less than 40 lbs per LHA)
- Only one Liquid Tight conduit per light unit
- Optical Lens hardened against sandblast
- Optical Chamber Sealed against moisture and dust
- Streamlined mounting leg assemblies
- Retrofits directly on ALC incandescent installations
- External Junction Box (PDU) configurations available
- FAA Class 2: -55° C



Specifications

General Catalog Numbers

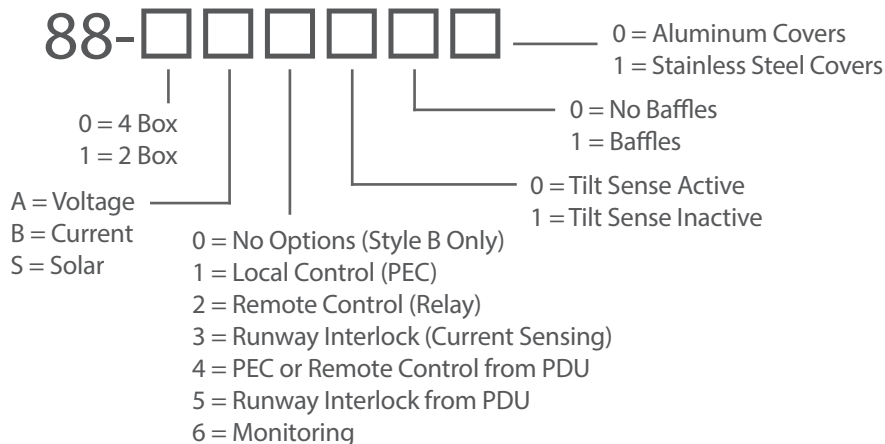

Replacement Parts

Part #	Description
88-00100	Control / Tilt Board
88-00250	LED Light Engine Kit
88-00300	RS485 Communications Board
88-00400	Power Conditioning Board
88-04000	LED PAPI Top Assy with PEC
88-00600	Display Board
88-00700	Power Supply, Style A
88-00205	Heated Lens Installation Kit
44-00175	Power Supply, Style B
59-E	Frangible Coupling
34-200666	L-830-6 200W 6.6A/6.6A Isolation Transformer

Electrical Characteristics, Style A

Input Power 108-265VAC 50/60Hz	Lens Heater Inactive	Lens Heaters Active
L-880 (4 Box)	200 VA	260 VA
L-881 (2 Box)	100 VA	130 VA

Electrical Characteristics, Style B

Using a 200W Isolation Transformer	Lens Heater Inactive	Lens Heaters Active
L-880(L) (4 Box)	276 VA	356 VA
L-881(L) (2 Box)	138 VA	178 VA

TABLE OF CONTENTS



Airport**Lighting**Company
An ISO 9001:2015 Certified Company

How to Get Help	1
Warranty	2
Theory of Operation	3
Electrical Characteristics	4
Wiring	5
Block Wiring Diagram 88-XA(1,2,3)XXX	5
Block Diagram 88-XA(4,5)XXX	6
Block Diagram DWG 88-XB0XXX	7
System Wiring, Style A	8
System Wiring, Style B	9
LHA Wiring	10
Installation of the LHA	11
Proper Grounding	12
Left Side Wiring 88-91500 Style A Primary LHA (Local/PEC)	13
Left Side Wiring Primary LHA Options	14
Left Side Wiring 88-92000 Style A Secondary LHA	15
Left Side Wiring 88-92000 Style B LHA	16
Top Wiring	17
DIPSwitch Configurations	18-20
Installation	21
Leveling and Tilting the LHA	21
Adjustment of Baffles	22
Maintenance	23
Troubleshooting	24
Troubleshooting Table	24
Replacing the Control and Tilt Board 88-00100	25
Replacing the RS485 Communications Board 88-00300	26
Replacing the Power Conditioning Board 88-00400	27
Replacing the Photosensor 88-00500	28

TABLE OF CONTENTS



Airport**Lighting**Company

An ISO 9001:2015 Certified Company

Assembly	29
LED PAPI LHA Assembly	30
Parts List	31
Additional Part Numbers	31
Harnesses	32-33
Notes	34



Have Questions? Contact Us:



PHONE: (315) 682-6460



EMAIL: info@airportlightingcompany.com



WEBSITE: www.airportlightingcompany.com

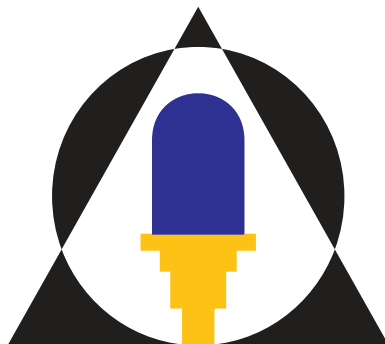

Airport**Lighting**Company

An ISO 9001:2015 Certified Company

**108 Fairgrounds Drive
Manlius, New York 13104**



Statement of Warranty

Warranty – LED Light Source Products FAA EB67D Products manufactured by Airport Lighting Company (ALC) which use LEDs as a light source are warranted against mechanical and physical defects in design or manufacture for a period of 2 years from date of installation per the applicable FAA Advisory Circular and against electrical defects in design or manufacture of the LED or LED specific circuitry for a period of 4 years per FAA EB67D. ALC will correct such defects by repair or replacement, at its option, provided the products have been properly handled and stored prior to installation, properly installed and operated after installation, and provided further that the Buyer has notified ALC in writing within the warranty period and within a reasonable time after notice of such defects. Refer to handling, storage, installation and operational instructions for proper procedural guidance that must be followed to maintain warranty provisions.

This warranty is in effect for the specified term as long as the equipment, in ALC's judgment, has not been altered in such a way as to affect the equipment adversely, subject to accident, negligence, improper storage, and has been operated and maintained in accordance with accepted FAA guidelines as described in AC 150/5340-26 and ALC's published operational guidelines.

ALC reserves the right to examine products about which a claim has been made. Equipment must be presented in the same condition as when the defect was discovered. ALC also reserves the right to require the return of equipment to establish any claim.

Disclaimer: ALC's obligation under this warranty is limited to repair or replacement of defective equipment sold by ALC at no cost to Buyer. This does not include any other costs such as the cost of removal, shipping, or installation of the defective part or repaired or replaced product, including labor or any consequential damages of any kind. Warranty services provided under this agreement do not assure uninterrupted operations of LED illuminated equipment. ALC shall not be liable for any indirect or consequential damages.

ALC's liability under no circumstances will exceed its sales price of the products claimed to be defective. All transportation costs under this warranty are the responsibility of the purchaser. Replacement parts and/or equipment provided under this warranty are covered under the same terms until the expiration of the original warranty period that began upon the first installation of the equipment.

This is ALC's sole and exclusive warranty with respect to the equipment sold to the Buyer. There are no express or implied warranties of fitness for any particular purpose or any implied warranties other than those made expressly herein.

ALC shall not be liable to the purchaser of this product or third parties for indirect or consequential damages, or for damages arising from the use of any options or parts other than those designated by ALC as approved products. Damage caused by lightning, flood and other natural or manmade causes are outside the scope of this warranty.



Theory of Operation

The Airport Lighting Company LED PAPI provides beneficial visual approach slope guidance to assist the pilot of an aircraft in flying a stabilized approach.

The FAA Type L-880 PAPI system consists of 4 Light Housing Assemblies (LHA) located adjacent to the origin of the glide path. Each LHA is installed at an offset from the desired glide path, which is midway between the central pair of LHAs. The outer pair are slightly more offset from the glide path than the inner pair. This configuration provides an increasing number of white signals as the incoming aircraft deviates above the intended glide path, and an increasing number of red signals as the incoming aircraft deviates below the desired glide path. An approach along the desired glide path will yield two red signals and two white signals.

The FAA Type L-881 PAPI system consists of 2 LHAs installed at angles equally above and below the glide path. An approach along the desired glide path will yield one red signal and one white signal.

The ALC LED PAPI includes a mercury-free electronic failsafe inclinometer to prevent operation if an LHA is raised 0.5 degrees or lowered 0.25 degrees from its set angle.

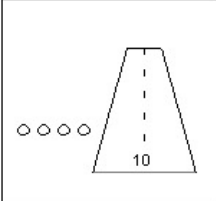
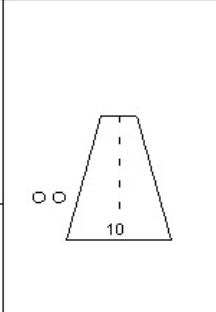
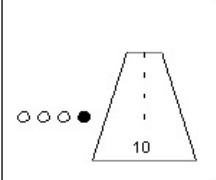
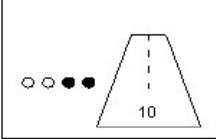
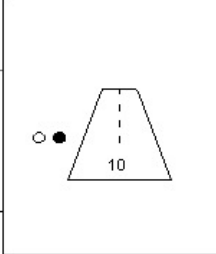
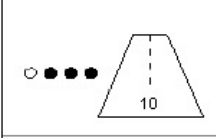
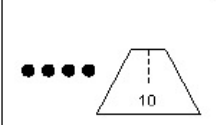
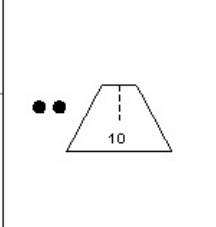
L-880		L-881	
	TOO HIGH 4 - White 0 - Red		TOO HIGH 2 - White 0 - Red
	SLIGHTLY HIGH 3 - White 1 - Red		
	ON GLIDEPATH 2 - White 2 - Red		ON GLIDEPATH 1 - White 1 - Red
	SLIGHTLY LOW 1 - White 3 - Red		
	TOO LOW 0 - White 4 - Red		TOO LOW 0 - White 2 - Red

Electrical Characteristics

FAA Style A (Voltage) systems are designed for use with an AC input of 120-240VAC Nominal 50/60Hz. FAA Style B (Current) systems are designed for use with series circuits of 6.6A or 20A. Solar systems are designed for use with a DC voltage input.

Each Light Housing Assembly (LHA) includes its own AC/DC power supply. All configurations make use of a Primary LHA which monitors and controls the Secondary LHAs. Voltage-driven configurations are available with an optional external Power Distribution Unit (PDU).

Style A (120-240VAC Nominal 50/60Hz)

	Lens Heaters Inactive	Lens Heaters Active
L-880(L) 4 Box	200 VA	260 VA
L-881(L) 2 Box	100 VA	130 VA

Style B (2.8-6.6A w/ 200W isolation transformer)

	Lens Heaters Inactive	Lens Heaters Active
L-880(L) 4 Box	276 VA	356 VA
L-881(L) 2 Box	138 VA	178 VA

Solar (48VDC)

	Lens Heaters Inactive	Lens Heaters Active
Each LHA (Night)	0.5A	1.9A
Each LHA (Day)	1.4A	2.9A

Packaged Characteristics

Weights

LHA & Mounting Kit	60 lbs
L-881 (2 Box) Cord Set	5.5 lbs
L-880 (4 box) Cord Set	11 lbs

Dimensions

LHA	29 x 21 x 12
Cord Set	13 x 13 x 9

Block Wiring Diagram 88-XA(1,2,3)XXX

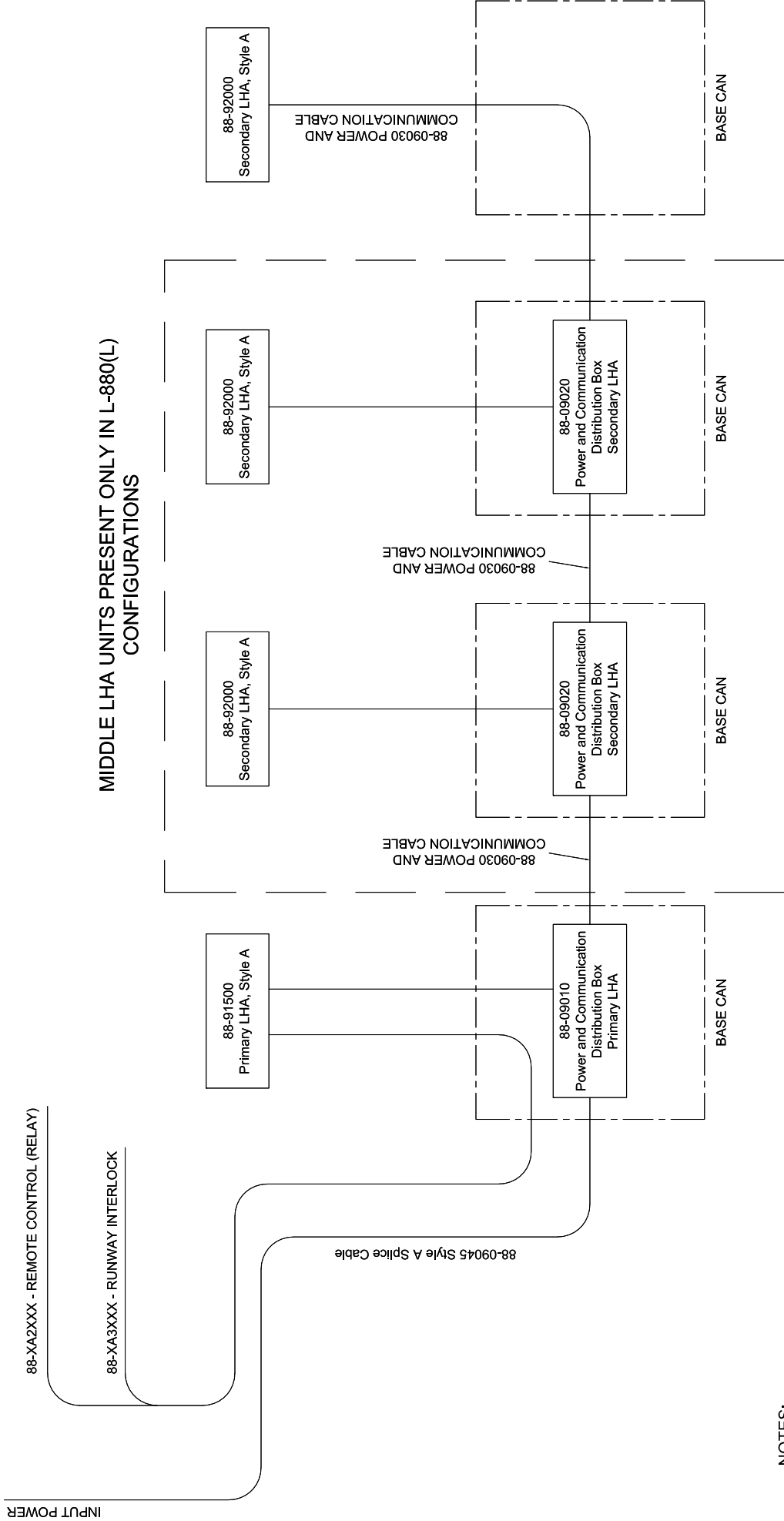

- NOTES:**
- 1 - INPUT POWER IS 120-240V 50/60HZ NOMINAL
 - 2 - REFER TO USER MANUAL FOR ADDITIONAL INFORMATION

Block Diagram 88-XA(4,5)XXX

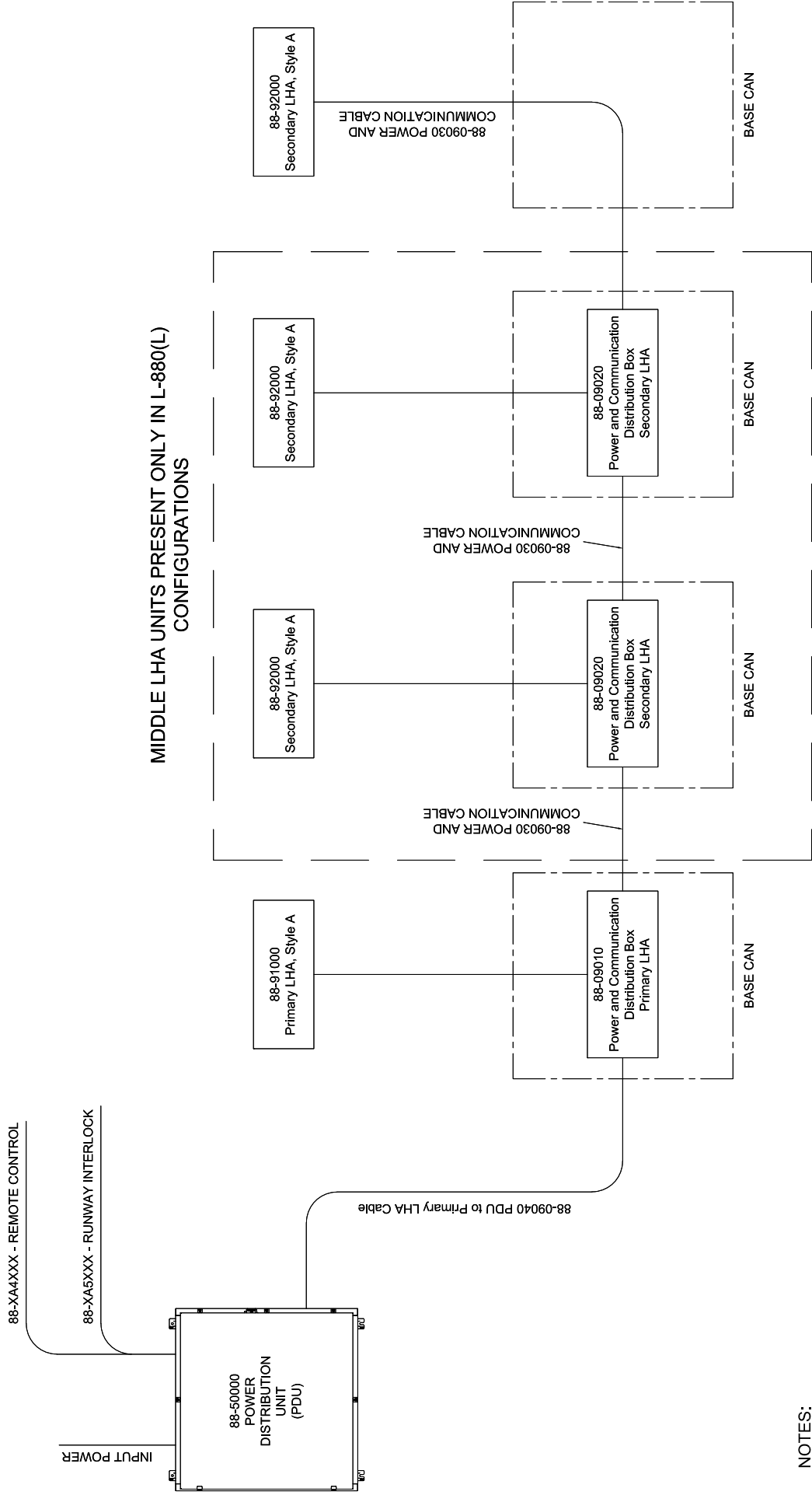

- NOTES:**
- 1 - INPUT POWER IS 120-240V 50/60HZ NOMINAL
 - 2 - REFER TO USER MANUAL FOR ADDITIONAL INFORMATION

Block Diagram DWG 88-XB0XXX

MIDDLE LHA UNITS PRESENT ONLY IN L-880(L) CONFIGURATIONS

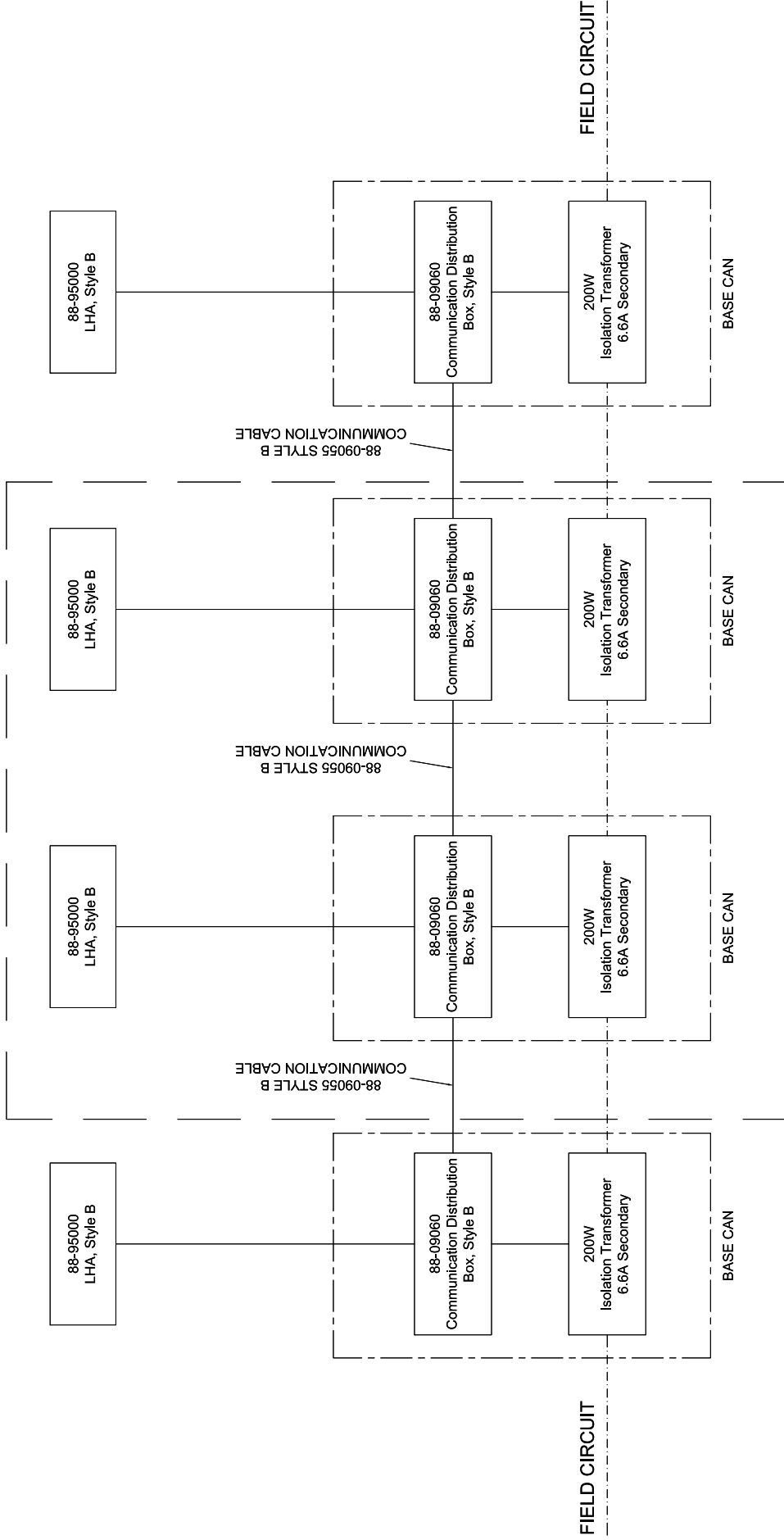

- NOTES:**
- 1 - VERIFY ISOLATION TRANSFORMER PROVIDES 6.6A SECONDARY
 - 2 - REFER TO USER MANUAL FOR ADDITIONAL INFORMATION

System Wiring, Style A

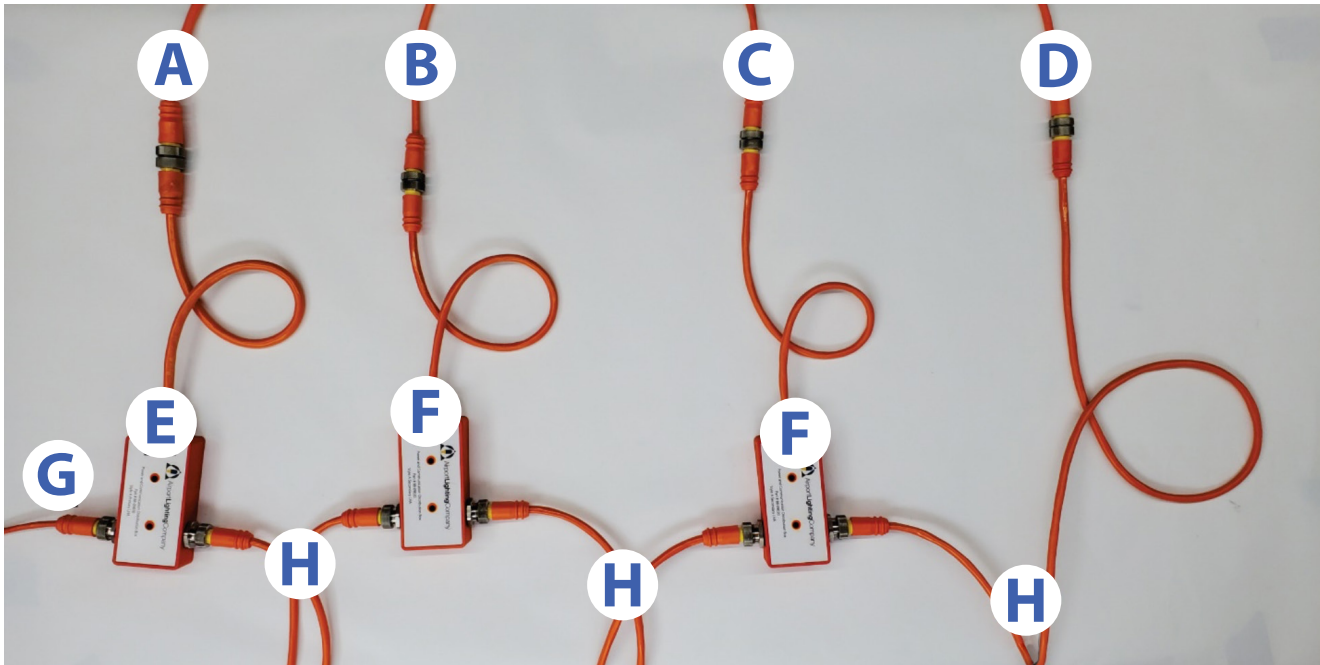

System ID	88-xA1xxx	88-xA2xxx	88-xA3xxx	88-xA4xxx 88-xA5xxx	88-xA6xxx
Configuration	PEC	Remote Control	Runway Interlock	PDU	Monitoring
A	88-02200	88-02210	88-02210	88-02100	88-02210
B	88-02300	88-02300	88-02300	88-02300	88-02300
C	88-02300	88-02300	88-02300	88-02300	88-02300
D	88-02300	88-02300	88-02300	88-02300	88-02300
E	88-09010	88-09011	88-09012	88-09010	88-09012
F	88-09020	88-09020	88-09020	88-09020	88-09020
G	88-09045	88-09040	88-09045	88-09040	88-09040
H	88-09030	88-09030	88-09030	88-09030	88-09030

System Wiring, Style B

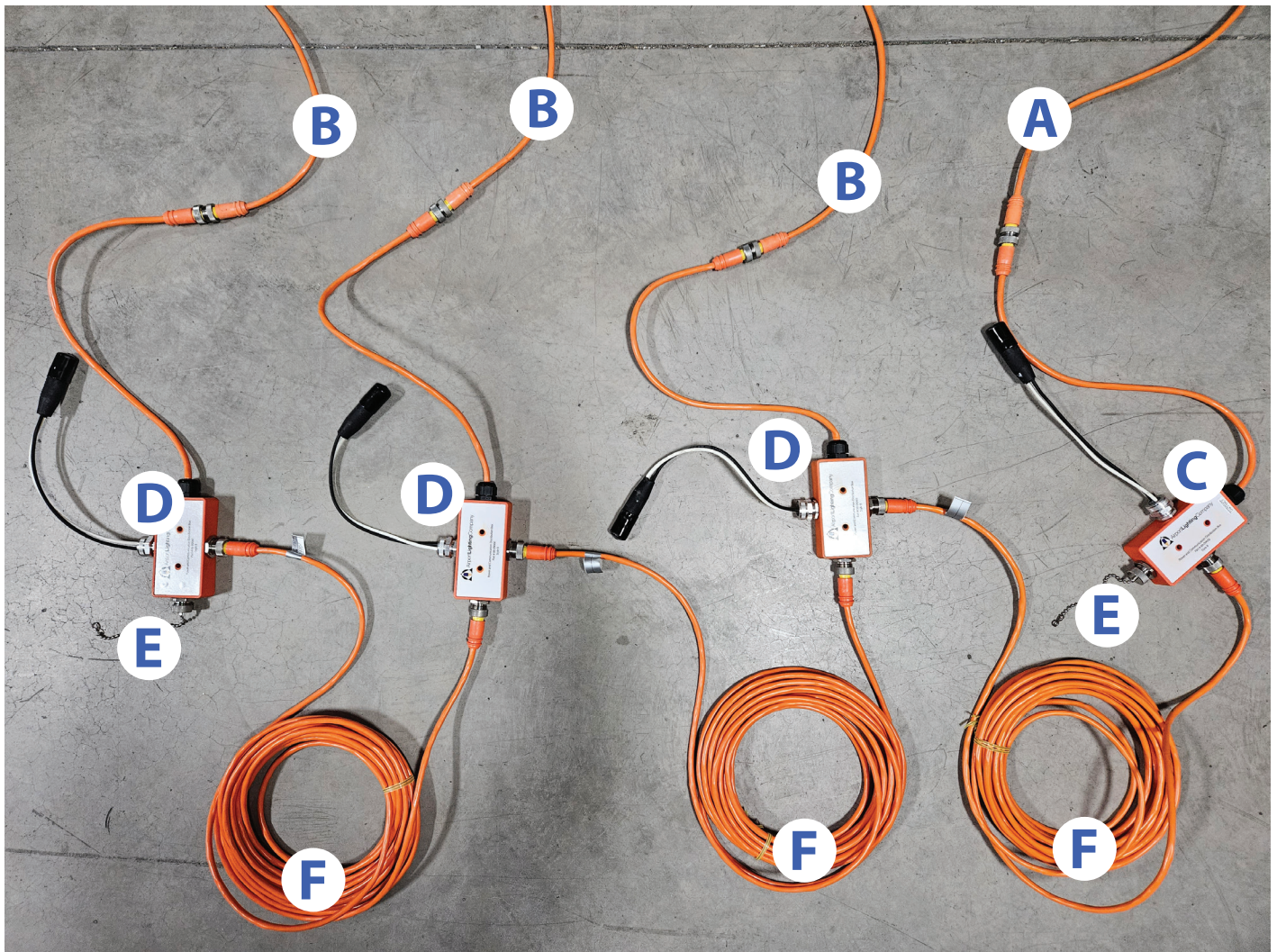

System ID	88-xB0xxx	88-xB6xxx
	No options	Monitoring
A	88-02500	88-02550
B	88-02500	88-02500
C	88-09060	88-09061
D	88-09060	88-09060
E	88-09070	88-09070
F	88-09055	88-09055

LHA Wiring

Each LHA includes a factory molded power and communications cable that will plug into a factory molded receptacle secured to a baseplate and mounted at grade.

At-Grade Connection

The receptacle from the distribution box passes through the baseplate opening. It is held above the opening by attaching an ALC #900 cable clamp (included in 88-09000 mounting kit) to the molded end.

NOTE: Style A Primary LHA and Style B Primary LHA with Monitoring Option require a special baseplate which has a larger opening for the cable than a standard baseplate. For L-867B cans use 88-01932 and for L-867D cans use 88-02932.

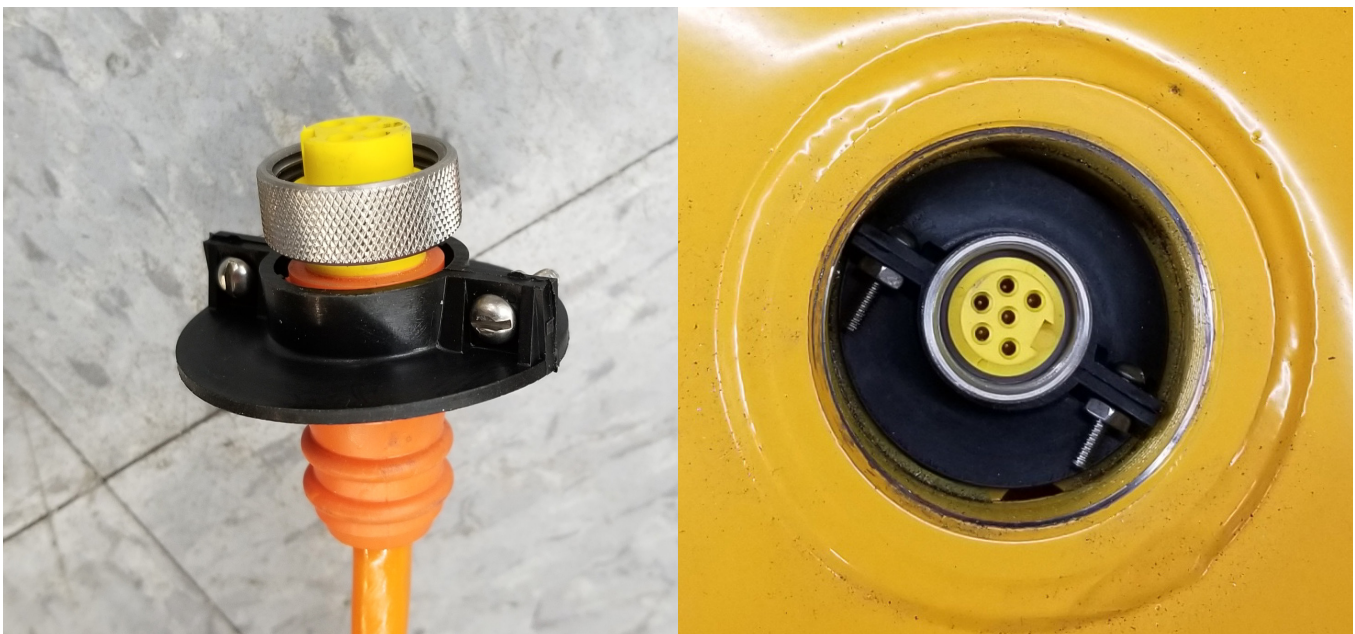

Installation of the LHA

The Airport Lighting Company LED PAPI is configured for quick and simple installation and aiming. Typically, the contractor need supply only 2" EMT for the legs and liquid tight flexible conduit. Most LHAs use 1-1/4". **Style A Primary LHAs for systems with Interlock Remote or Monitoring Options will use 1-1/2".**

Except in situations with special siting considerations, the center of the lens must be within in +/- 1 inch of a horizontal plane that is within +/- 1 foot of the elevation of the runway centerline at the intercept point of the visual approach angle with the runway.

Establish the height of this plane above mounting grade for each LHA and cut three pieces of EMT to 13" less than this.

Assemble each leg and put in its place. Remove the top flange and hex nuts. Lower the LHA on to the lower flange nuts. Replace the top flange and hex nuts. Do not tighten the top flange nuts until after leveling and tilting the unit. Use the hex nuts to jam the flange nuts in place.

Run the LHA whip through contractor-supplied liquid tight conduit from the elbow at the LHA to the straight connection at the frangible coupling, connecting at grade with the whip from the distribution box in the L-867 base. In Style A installations, the final LHA in the sequence will have no distribution box in the L-867 base and will be connected to a cable run from the previous LHA's L-867 base can.

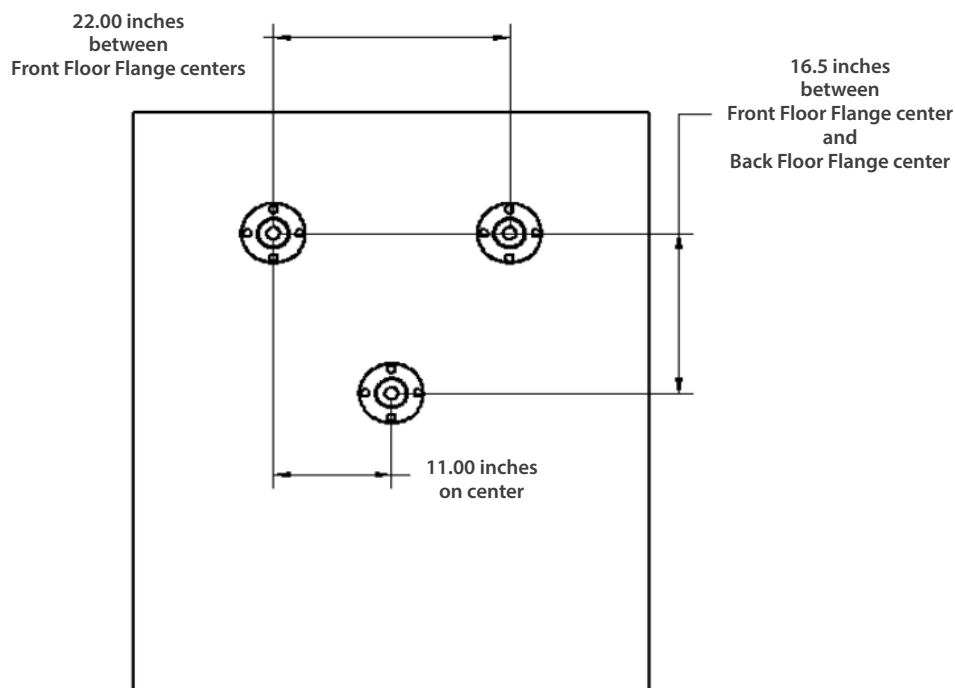

Proper Grounding

Each LHA is equipped with a grounding lug. Install a grounding wire connecting this lug to a ground rod.

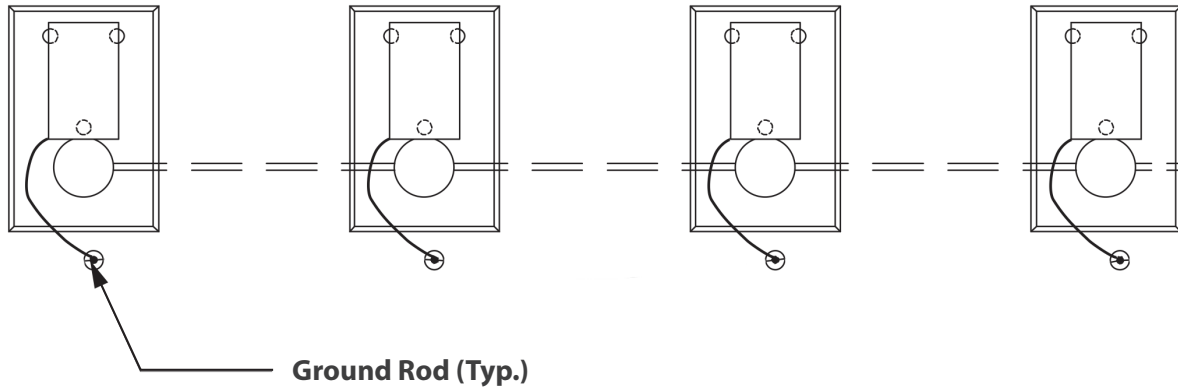

Ground Lug

The ground lug position is inverted for shipping. Remove the hex socket with a 5/32 bit to rotate the lug 180° prior to inserting the ground wire.



Wiring, Left Side

88-91500 Style A Primary LHA (Local/PEC)

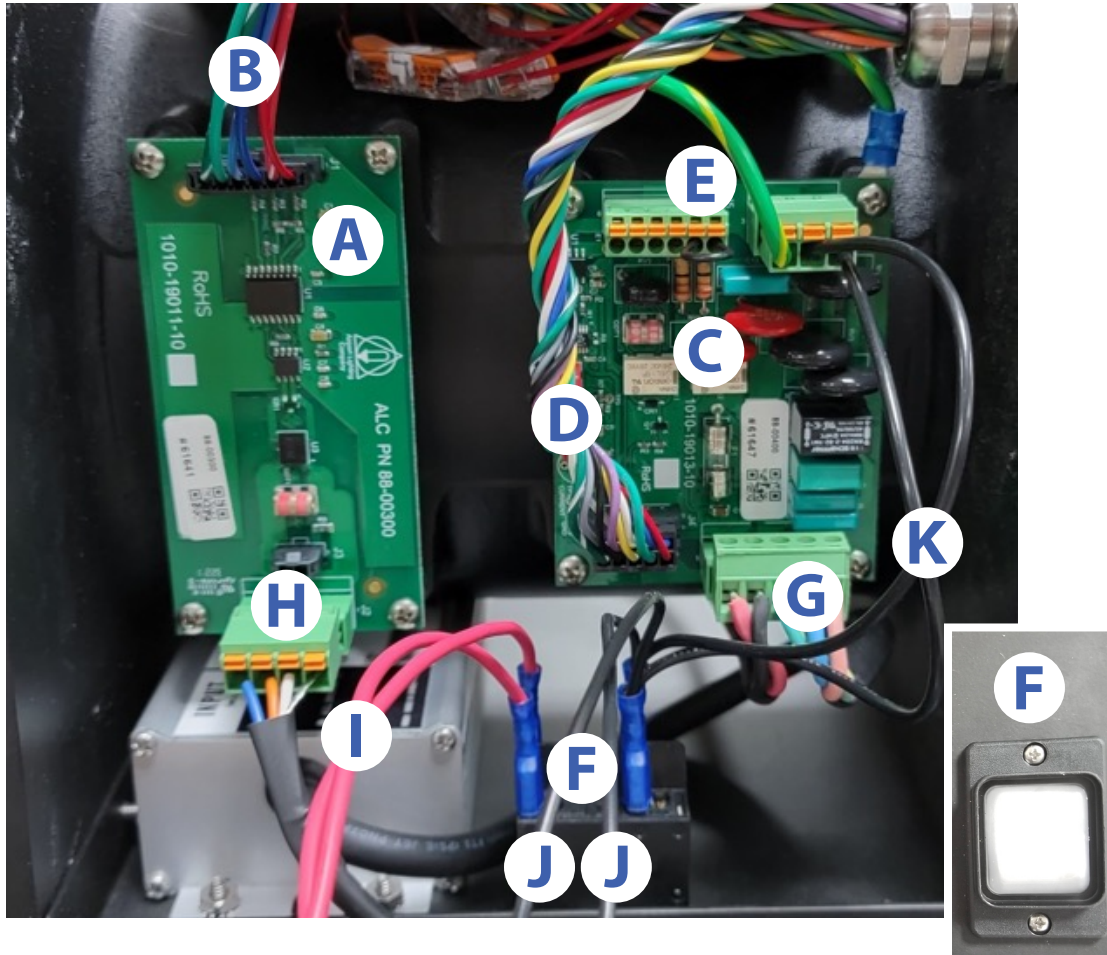

A	RS 485 Board	88-00300	
B	RS 485 Harness	88-00035	
C	Power Conditioning Board	88-00400	I Input Voltage
D	Main Harness	88-00036	J Output to Secondary LHAs
E	Jumper*	55-00416	K Input to Power Conditioning Board
F	Circuit Breaker	88-00050	
G	Power Supply Connection From Whip Assembly (88-02200)		
H	RS485		

* Not used with Remote or Runway interlock options.

Wiring, Left Side Primary LHA Options

The below images indicate the routing of the input wires to J5 on the 88-00400 Power Conditioning Board of the Primary LHA.

Style A with Remote Control

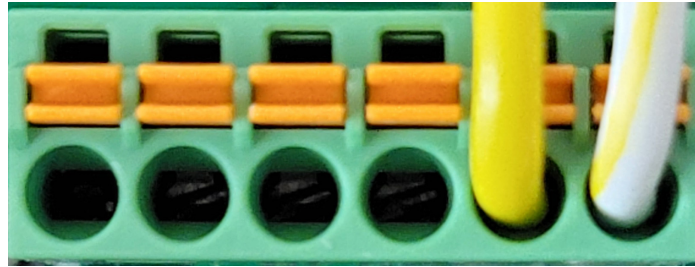

Style A with Runway Interlock

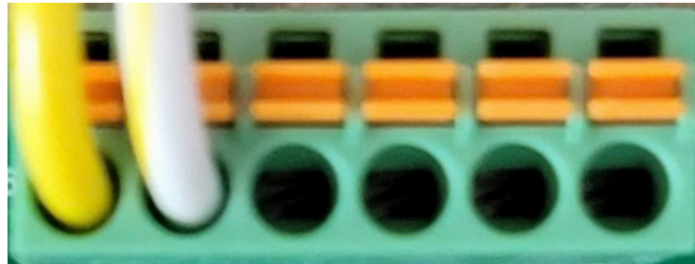

Style A with Monitoring



Style B with Monitoring

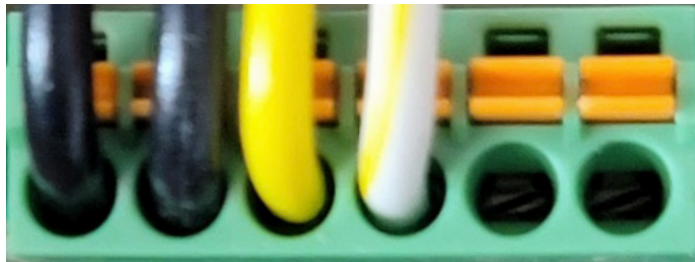

Wiring, Left Side

88-92000 Style A Secondary LHA

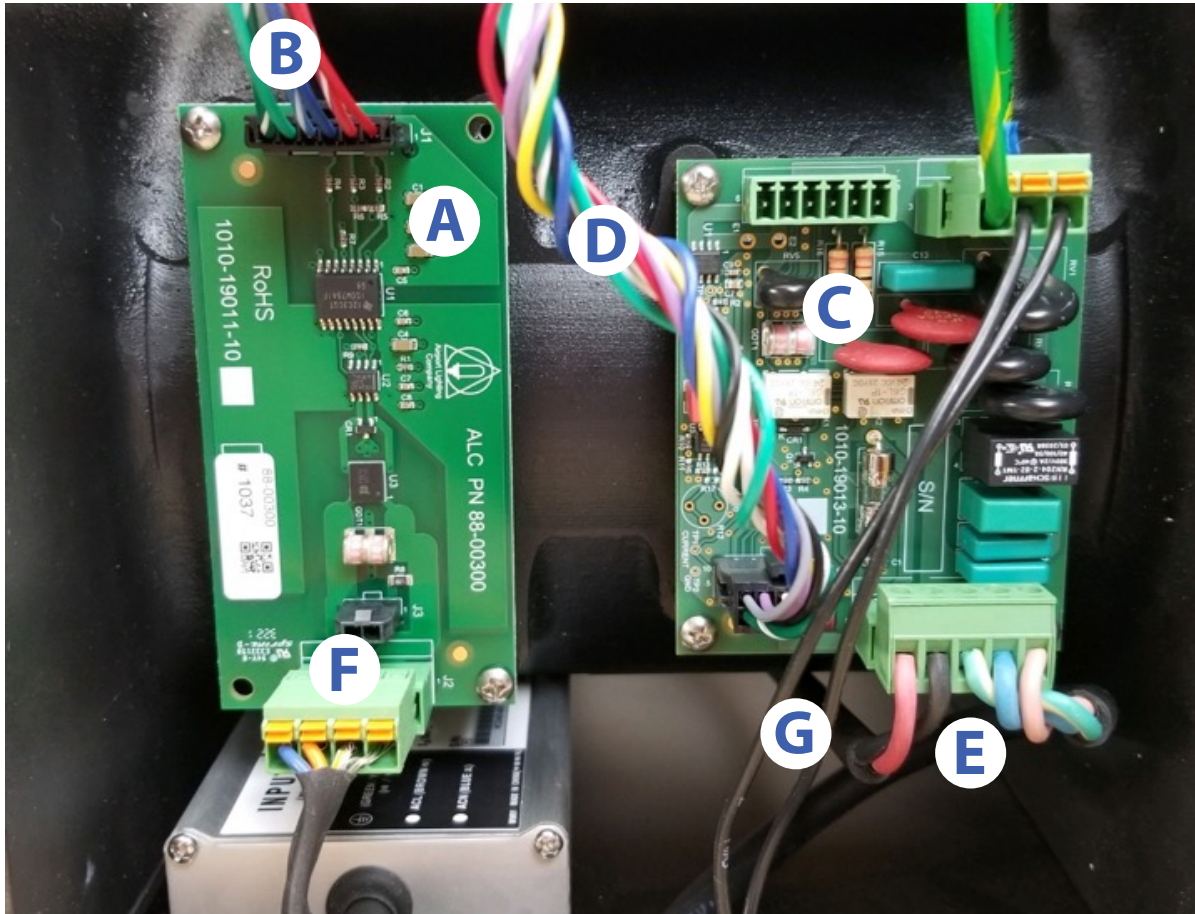

- | | | |
|----------|--|-----------------|
| A | RS 485 Board | 88-00300 |
| B | RS 485 Harness | 88-00035 |
| C | Power Conditioning Board | 88-00400 |
| D | Main Harness | 88-00036 |
| E | Power Supply Connection
From Whip Assembly (88-02300) | |
| F | RS485 Connection from Whip Assembly (88-02300) | |
| G | Input Voltage | |

Wiring, Left Side 88-92000 Style B LHA

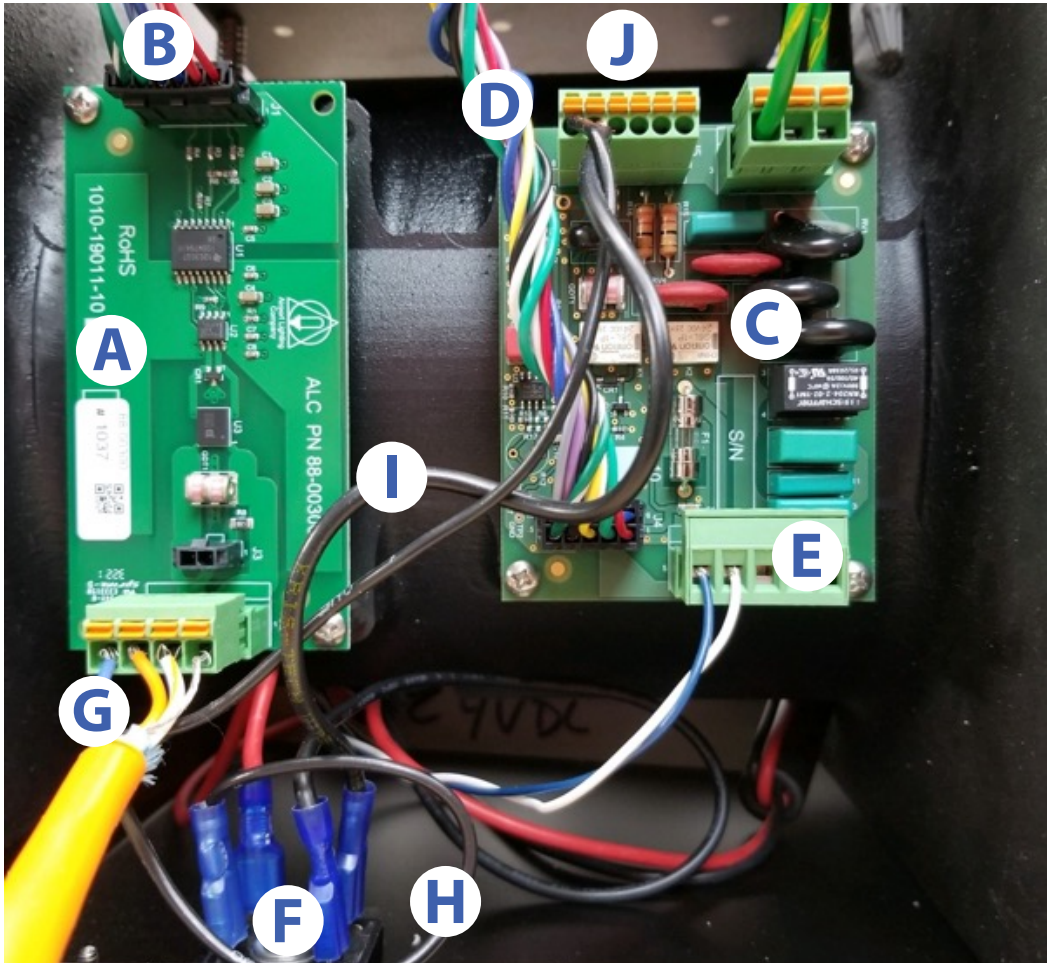

A	RS 485 Board	88-00300	G	RS485 Connection From Whip Assembly (88-02300)
B	RS 485 Harness	88-00035	H	Direct Connection to Bridge
C	Power Conditioning Board	88-00400	I	Connection to Bridge via Current Sensing Connection
D	Main Harness	88-00036	J	Current Sensing Connection
E	Power Supply Connection			
F	Bridge Rectifier From Whip Assembly (88-02500)	44-00174		

Wiring, Top

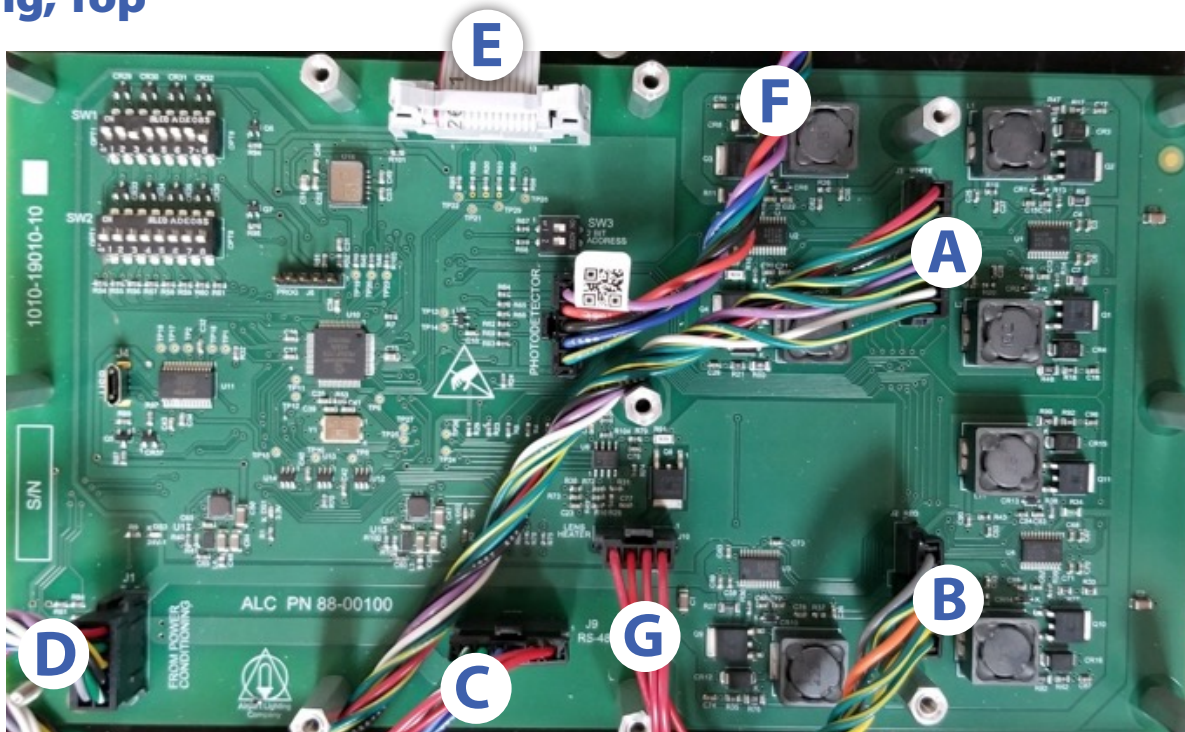

A	LED Harness – RED	88-00200 J1
B	LED Harness – White	to 88-00200 J2
C	RS485 Communication Harness	to 88-00300 J1
D	Main Harness	to 88-00400 J4
E	Display Ribbon	to 88-00600 J1
F	Photosensor Harness	to 88-00500
G	Lens Heater Harness	to 88-00005

Installation/Test Modes

If any units are placed in Test Mode, all units not in Test Mode will extinguish and indicate a COMM 485 FAIL.

Test Mode 1: Unit ignores all fault conditions. Used when setting Tilt and Glide.

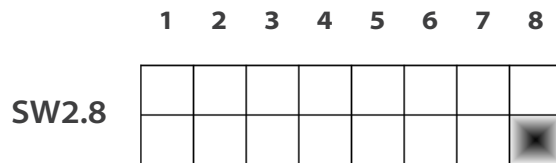

Test Mode 2: Unit ignores RS485 Comm faults.

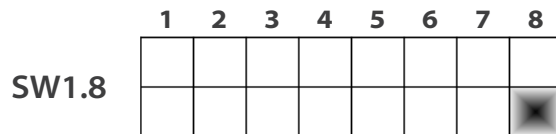

Test Mode Performance

SW1.6-7 control the light output of an LHA that has been put into Test Mode



LEDs on



LEDs off



Night intensity



Day intensity

SW2

SW2.1-4 allow the user to modify performance of a unit or system that is in Normal Operation

Lens Warming (Style B Only)

SW2.1 can be engaged to keep the lenses warm without illuminating the LEDs

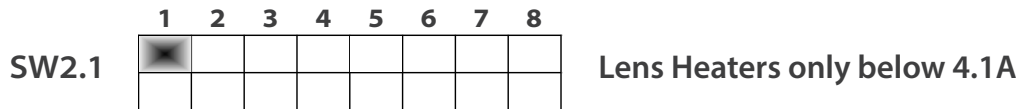

HEAT FAIL

In Normal Operation, the system will extinguish if an LHA senses a HEAT FAIL.

SW2.2 can be engaged to override that response.

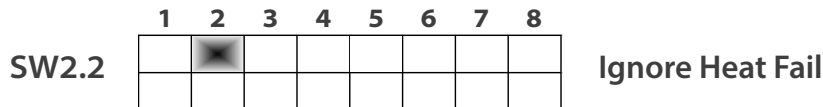

LED FAIL

In Normal Operation, the system will extinguish if an LHA senses an LED FAIL.

SW2.3 can be engaged to override that response.

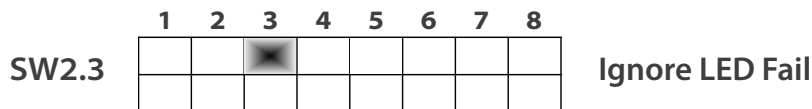

Heater Disable

In Normal Operation, the lens heaters are thermostatically controlled.

SW2.4 can be engaged to disable the heaters.

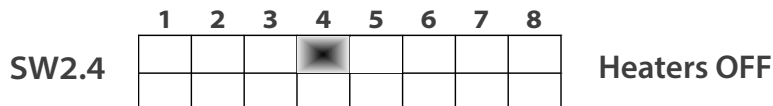

SW3

LHA ID

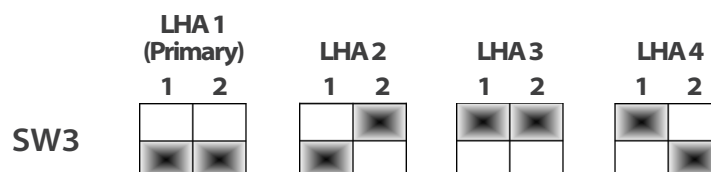

Normal Operation

In Normal Operation, Switches SW1.1-4 are used to define settings. All SW2 switches are OFF.

Style SW1-1,2 are used to indicate Style A (Voltage) or Style B (Current)

	1	2	3	4	5	6	7	8	
SW1-1,2		✖	✖						Style B (Current)
SW1-1,2	✖	✖							Style A (Voltage) PEC or Remote Control
SW1-1,2	✖		✖						Style A (Voltage) Runway Interlock Day on. Night current sense
SW1-1,2	✖		✖						Style A (Voltage) Runway Interlock Day and Night current sense

Type SW1.3 is used to indicate Type

	1	2	3	4	5	6	7	8	
SW1.3			✖						2 box system (L-881)
SW1.3			✖						4 box system (L-880)

Night Intensity SW1.4 is used to indicate the Style A Night Intensity

	1	2	3	4	5	6	7	8	
SW1.4				✖					5%
SW1.4				✖					20%

Tilt Fail Response SW1.5 enables or overrides the system's response to an LHA deviating from its set GLIDE angle

	1	2	3	4	5	6	7	8	
SW1.5					✖				LEDs off (FAA)
SW1.5					✖				LEDs remain on



Leveling and Tilting the LHA

- Remove the Top Cover of the LHA. Take care on the Primary unit to not stress the harness for the Photosensor.
- Set switchers to Test Mode 1 (SW1-8 ON, SW2-8 OFF). This allows the system to operate while ignoring Tilt or Comm failures.
- Remove the top flange nuts on each mounting leg.
- Energize System using the Circuit Breaker in the PDU.
- Press the LEVEL button to begin horizontal leveling.
- Use the lower flange nuts on the two front legs to adjust the LHA until the display reads 0.00.
- Press the GLIDE button.
- Use the lower flange nut on the rear leg to adjust the angle of the LHA until the display reads the desired angle in Decimal Degrees.
- Replace and tighten upper flange nuts, making any minor adjustments required to maintain display or desired angle.
- Press SET until display reads SAVE.
- LHA is now set to detect deviation from desired Glide slope.
- Once all the LHAs are returned to Normal, the system will return to full functionality.
- Replace top cover

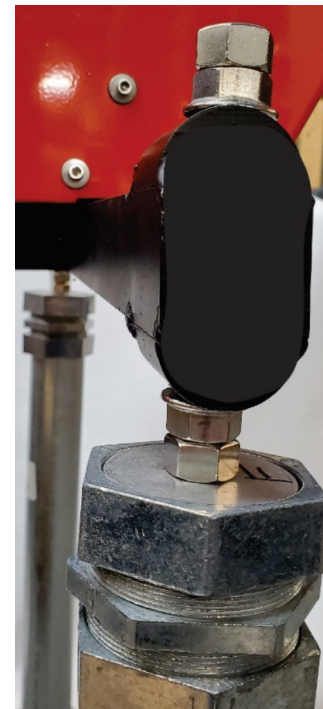

Adjustment of Baffles

The Airport Lighting Company LED PAPI comes with integral baffles for narrowing the beam signal in cases where there are obstructions that would interfere with a signal of typical width. Adjustment screw holes are located on each side of the LHA. Because the lensing system inverts the signal image, each screw reduces the beam as viewed from the opposite side.

- **Remove the top cover of the LHA**
- **Set to Test Mode 1 (SW1-8 ON, SW2-8 OFF)**
- **Loosen the top flange nuts on each mounting leg**
- **Raise the rear of the LHA until the display indicates a glide slope of approximately 0.00. This will allow the signal to be observed downfield at the desired beam cutoff point.**
- **Station an observer downfield along the desired cutoff angle**
- **Remove the screw(s) from the side(s) opposite the desired baffling**
- **Thread the jam nut all the way down the baffle adjustment screw**
- **Install the baffle adjustment screw until the downfield observer notes the correct level of baffling**
- **Tighten the jam nut against the housing to secure the baffle adjustment screw**
- **Lower the rear of the LHA until the display indicates the desired glide slope angle**
- **Tighten the three top flange nuts and jam nuts on the mounting legs**
- **Once all the LHAs are returned to Normal, the system will return to full functionality.**
- **Replace the top cover**

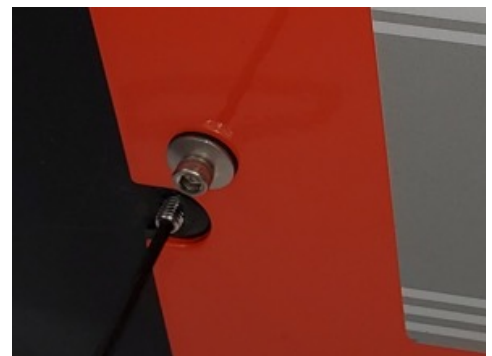

Maintenance

The Airport Lighting Company LED PAPI is designed for years of trouble-free operation. The following are recommended regular maintenance actions.

- **Compare and track actual tilt angle (displayed) to set tilt angle by pressing STATUS.**
- **Clean the lens**
- **Clean the photosensor cover**
- **Check all mounting hardware and tighten as required**
- **Check for any LED failures by holding a piece of paper in front of the lens where the LED pattern can be clearly seen. IF failures are observed, make sure a spare LED board is available. The unit will cease to operate before 25% of either color have failed and the board will need to be replaced.**

Troubleshooting Table

Fault information will appear on the LHA at fault.

Displayed Error	Cause	Solution
COMM 485 LOST	Loose connection in LHA	Check connections in LHA and tighten
	Failed RS 485 Board	Replace RS 485 Board
PHOT FAIL	Loose harness connection	Check harness for loose connection
	Failed Photosensor Board	Replace Top Assembly
TILT FAIL UNTx	Incorrect position of LHA x	Adjust LHA x until desired glide slope is displayed and Re-Set
	Failed Control and Tilt Board	Replace Control and Tilt Board
LED FAIL	Number of failed LEDs exceeds allowable maximum	Replace LED board and Calibrate
HEAT FAIL	Failed thermostat	Replace heated lens assembly
	Failed heater	Replace heated lens assembly

Replacing the Control and Tilt Board 88-00100

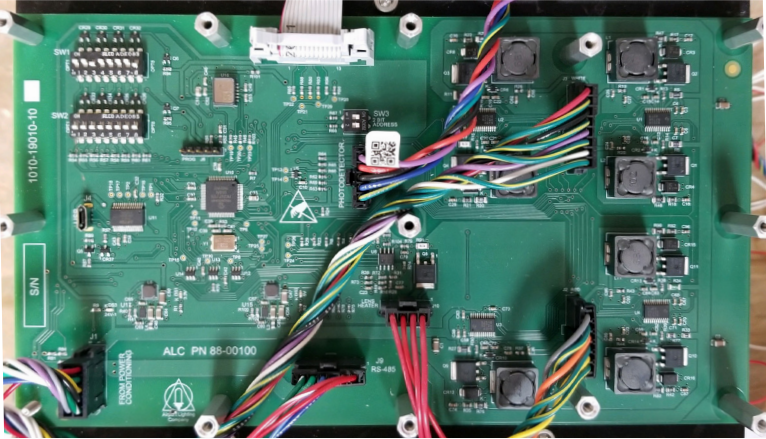
- De-energize the system using the circuit breaker
 - Remove the top cover of the LHA
 - Disconnect all harnesses from the Control and Tilt Board
 - Remove the long hex standoffs
 - Lift the board gently off of the threaded studs, working gently around the edges on the board as needed
- 
- Set all three banks (SW1, SW2, and SW3) of switches on the new board to match those of the board being replaced
 - Set the new board on the threaded studs
 - Gently press the board down onto the studs working in circular patterns from the center outward
 - Return the hex standoffs to the threaded studs, snugging by hand in a circular pattern starting from the center of the board
 - Re-attach all harness connections
 - Energize the system using the circuit breaker in the PDU
 - Place the unit into Test Mode 2 (SW1-8 OFF, SW2-8 ON)
 - Confirm all LEDs are illuminated by holding a sheet of paper in front of the LHA at a distance where the pattern on LEDs can be easily recognized
 - Press the SET button until the display reads CAL. The unit will cycle through each intensity (100%, 20%, 5%) and after the process has been completed, the display will resume indication of the glide slope.
 - Return the unit to Normal Operating Mode (SW1-8 OFF, SW2-8 OFF)
 - Replace the top cover

Replacing the RS485 Communications Board 88-00300

- De-energize the system using the circuit breaker
- Remove the Top Cover
- Remove the Left Cover
- Detach the harnesses from the board
- If there is a resistor in J3, remove it and install it into the new RS485 Communications Board
- Remove the 4 screws
- Hold the new RS485 Communications Board in place
- Replace the 4 screws
- Reattach the harnesses
- Replace the Left Cover
- Replace the Top Cover
- Re-energize the system

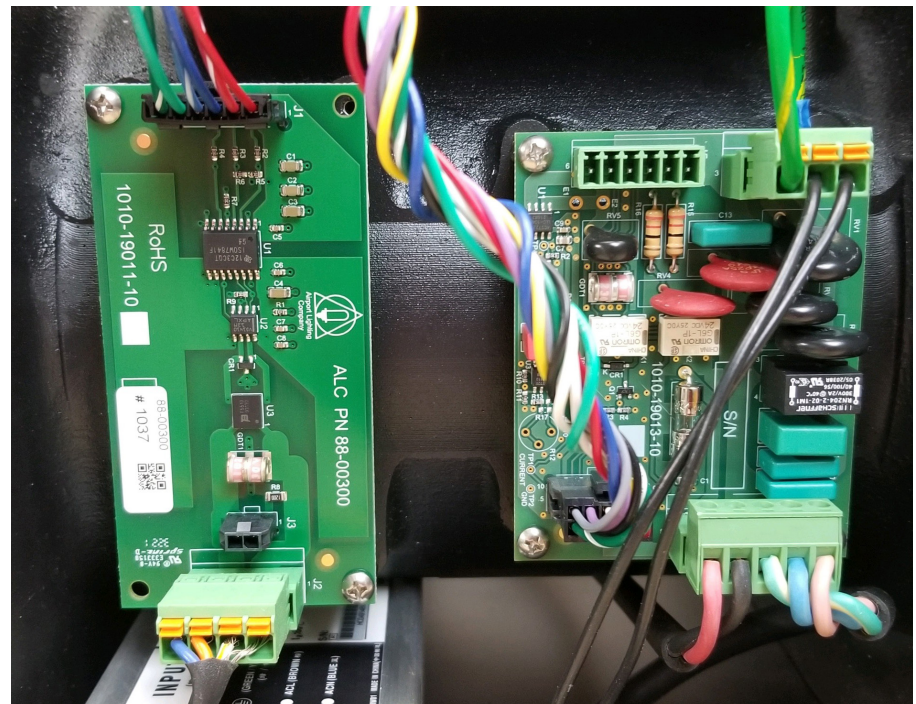

Replacing the Power Conditioning Board 88-00400

- De-energize the system using the circuit breaker
- Remove the Top Cover
- Remove the Left Cover
- Disconnect all harnesses from the Power Conditioning Board
- Note the position of the ground wire under the upper left screw
- Remove the 4 mounting screws
- Remove the Power Conditioning Board
- Install the new Power Conditioning Board with the 4 screws, making sure to replace the ground wire under the board with the upper right screw
- Plug in all harnesses
- Replace the Left Cover
- Replace the Top Cover
- Re-energize the system

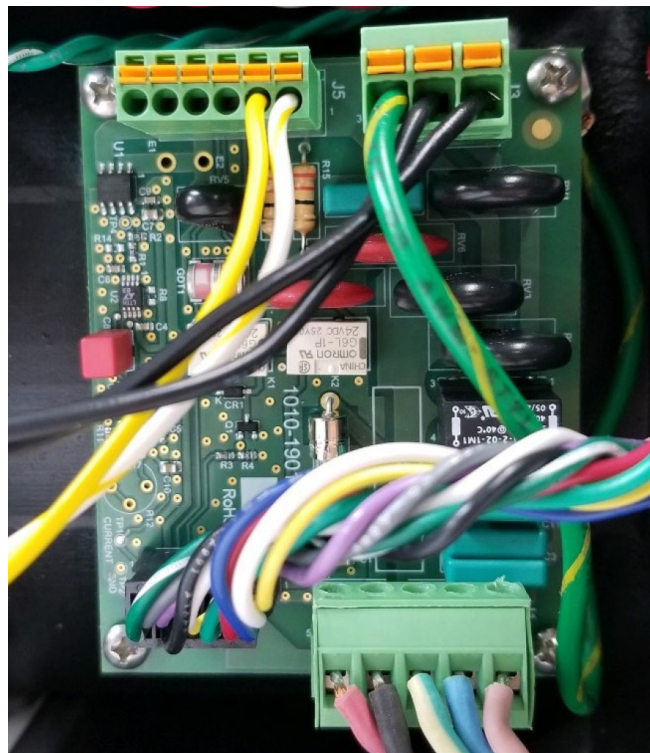



Replacing the Photosensor 88-00500

The photosensor is part of the 88-04000 Top Assembly with PEC and is not field replaceable independently.

- **De-energize the system using the circuit breaker**
- **Remove the four screws from the top**
- **Gently lift the top from the LHA**
- **Unplug the photosensor harness from the Control and Tilt Board**
- **Plug in the photosensor harness from the new Top Assembly**
- **Tighten the four screws**
- **Re-energize the system**

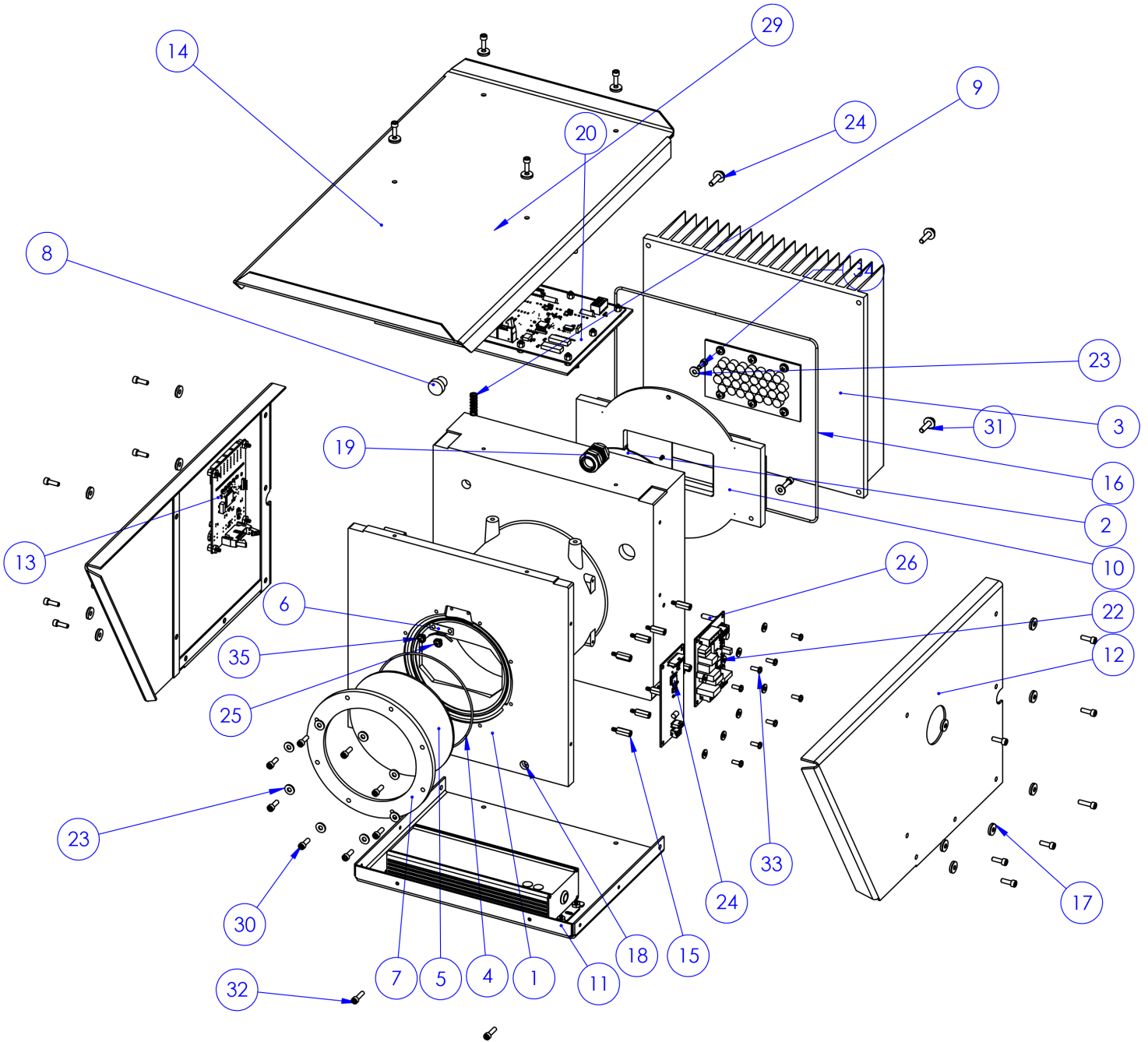

LED PAPI LHA Assembly

Item No.	Part Number	Description	Qty.
1	88-00001	Sandcast housing	1
2	88-00002	Intermediate Aperture	1
3	88-05000	Heatsink Assm	1
4	88-00004	EPDM O-Ring lens 1/16"	1
5	88-00005	Biconvex lens	1
6	88-00003	Spring clip for lens	1
7	88-00006	Retaining ring lens	1
8	88-00007	Gore vent	1
9	99-00261	Compression springs	3
10	88-07000	Baffle box assembly	1
11	88-01000	PSU & Botttom tray assembly	1
12	88-02000	Left cover panel assembly	1
13	88-03000	Right cover panel Assembly	1
14	88-00024 (Primary LHA), 88-00025	Top Cover Assembly	1
15	99-00262	Electronic spacer 6-32x 5/8"	8
16	88-00009	EPDM O-Ring heatsinke 3/32"	1
17	99-00263	Metal-Bonded Sealing Washer	20
18	99-00105	Stainless steel washer #8	2
19	88-00008	Stainless Steel Submersible Cord Grip	1
20	88-00100	Control and Tilt PCB	1
24	88-00300	Communication PCB	1
22	88-00400	Power Conditioning PCB	1
23	99-00105	SS washer #8	11
24	99-00090	SS washer #6	7
25	99-00090	SS washer #6	10
26	99-00286	10-32 x 2" cup point set screw	2
27	88-00030	1-1/4" Liquid Tite Elbow	1
29	99-00257	Stainless steel socket head cap screw #10-32x 7/8"	3
30	99-00258	Stainless steel socket head cap screw #8-32x 1/2"	26
31	99-00259	Stainless steel socket head cap screw #10-32x 3/4"	4
32	99-00260	Stainless steel socket head cap screw #8-32x 5/8"	6
33	99-00072	Stainless steel pan head screw #6-32x 3/8"	8
34	99-00245	Stainless steel socket head cap screw #8-32x 3/8"	1
35	99-00264	Stainless steel pan head screw #6-32x 1/4"	2



Additional Part Numbers

72	L-867B Baseplate with 2" threaded hub
902	Floor Flange
59-E	2" Frangible Coupling Assembly (Includes 59-B Body, 59-R Compression Ring, 59-N Nut)
88-00033	Liquid Tight Receiver
88-00032	Liquid Tight Fitting, 1-1/4" Straight
88-8A25	2" EMT Compression Coupling
88-8A31	Threaded Rod Receiver
88-00045	Threaded Rod
99-00007	1/2-13 Hex Nut
99-00006	1/2-13 Flange Nut
88-00034	LHA LED Harness
88-00035	LHA RS485 Harness
88-00036	LHA Power Conditioning Harness
88-01932	Special Baseplate 12"
88-02932	Special Baseplate 16"
88-09010	Style A Primary Distribution Box
88-09020	Style A Secondary Distribution Box
88-09030	Style A Power and Comm Cable
88-09045	Input Splice Cable, Style A
88-09060	Style B Distribution Box
88-09055	Style B Communications Cable
88-09070	Distribution Box Cap



Harnesses

88-00034

	88-00100	Color	88-00200
Run 1	J2-1	Gray	J1-6
Run 2	J2-2	Green/White	J1-5
Run 3	J2-3	Orange	J1-4
Run 4	J2-4	Green/White	J1-3
Run 5	J2-5	Yellow	J1-2
Run 6	J2-6	Green/White	J1-1
Run 7	J3-1	Red	J2-8
Run 8	J3-2	Green/White	J2-7
Run 9	J3-3	Black	J2-6
Run 10	J3-4	Green/White	J2-5
Run 11	J3-5	Violet	J2-4
Run 12	J3-6	Green/White	J2-3
Run 13	J3-7	White	J2-2
Run 14	J3-8	Green/White	J2-1

88-00035

	88-00100	Color	88-00300
Run 1	J1-1	Red	J9-1
Run 2	J1-2	Red/White	J9-2
Run 3	J1-3	Blue	J9-3
Run 4	J1-4	Blue/White	J9-4
Run 5	J1-5	Green	J9-5
Run 6	J1-6	Green/White	J9-6



Harnesses Continued

88-00036

	88-00100	Color	88-00400
Run 1	J1-1	Red	J1-1
Run 2	J1-2	Green	J1-2
Run 3	J1-3	Yellow	J1-3
Run 4	J1-4	Black	J1-4
Run 5	J1-5	Green/White	J1-5
Run 6	J1-6	Blue	J1-6
Run 7	J1-7	White	J1-7
Run 8	J1-8	White	J1-8
Run 9	J1-9	Violet	J1-9
Run 10	J1-10	Gray	J1-10

